



Table of Contents

| | | | |
|---|----|--|----|
| Table of Contents | 1 | SETUP | 43 |
| Usage Notice | 2 | <i>SETUP HDMI Link Settings</i> | 45 |
| <i>Safety Information</i> | 2 | <i>SETUP Signal (VGA)</i> | 47 |
| <i>Precautions</i> | 3 | <i>SETUP Signal (Video)</i> | 48 |
| <i>Eye Safety Warnings</i> | 6 | Appendices | 49 |
| <i>Flexible Angle Setting</i> | 6 | <i>Troubleshooting</i> | 49 |
| Introduction | 7 | <i>Image Problems</i> | 49 |
| <i>Package Overview</i> | 7 | <i>Other Problems</i> | 51 |
| <i>Product Overview</i> | 8 | <i>Remote Control Problems</i> | 51 |
| <i>Main Unit</i> | 8 | <i>LED Lighting Messages</i> | 52 |
| <i>Input/Output Connections</i> | 9 | <i>On Screen Messages</i> | 53 |
| <i>Remote Control</i> | 10 | Compatibility Modes | 54 |
| Installation | 11 | RS232 Commands and Protocol | |
| <i>Connecting the Projector</i> | 11 | <i>Function List</i> | 56 |
| <i>Connect to Computer/Notebook</i> | 11 | <i>RS232 Pin Assignments</i> | 56 |
| <i>Connect to Video Sources</i> | 12 | <i>RS232 Protocol Function List</i> | 57 |
| <i>Connect to 3D Video Devices</i> | 13 | Ceiling Mount Installation | 60 |
| <i>Using the 3D glasses</i> | 15 | Optoma Global Offices | 61 |
| <i>Powering On/Off the Projector</i> | 16 | Regulation & Safety Notices | 63 |
| <i>Powering On the Projector</i> | 16 | <i>FCC Notice</i> | 63 |
| <i>Powering Off the Projector</i> | 17 | <i>Declaration of Conformity for EU</i> | |
| <i>Warning Indicator</i> | 18 | <i>countries</i> | 64 |
| <i>Adjusting the Projected Image</i> | 19 | Trademarks | 65 |
| <i>Adjusting the Projector's Height</i> | 19 | | |
| <i>Adjusting the Projector's Position</i> | 20 | | |
| User Controls | 22 | | |
| Control Panel & Remote Control | 22 | | |
| <i>Control Panel</i> | 22 | | |
| <i>Remote Control</i> | 23 | | |
| On-screen Display Menus | 25 | | |
| <i>How to operate</i> | 25 | | |
| <i>Menu Tree</i> | 26 | | |
| IMAGE | 28 | | |
| <i>IMAGE Advanced</i> | 30 | | |
| <i>IMAGE Advanced PureEngine</i> | 31 | | |
| <i>IMAGE Advanced Color Settings</i> ... | 32 | | |
| DISPLAY | 34 | | |
| <i>DISPLAY 3D</i> | 39 | | |
| SYSTEM | 40 | | |

Safety Information

| | |
|---|---|
|  | The lightning flash with arrow head within an equilateral triangle is intended to alert the user to the presence of uninsulated "dangerous voltage" within the product's enclosure that may be of sufficient magnitude to constitute a risk of electric shock to persons. |
|  | The exclamation point within an equilateral triangle is intended to alert the user to the presence of important operating and maintenance (servicing) instructions in the literature accompanying the appliance. |

WARNING: TO REDUCE THE RISK OF FIRE OR ELECTRIC SHOCK, DO NOT EXPOSE THIS APPLIANCE TO RAIN OR MOISTURE. DANGEROUS HIGH VOLTAGES ARE PRESENT INSIDE THE ENCLOSURE. DO NOT OPEN THE CABINET. REFER SERVICING TO QUALIFIED PERSONNEL ONLY.

Class B emissions limits

This Class B digital apparatus meets all requirements of the Canadian Interference-Causing Equipment Regulations.

Important Safety Instruction

1. Do not block any ventilation openings. To ensure reliable operation of the projector and to protect from over heating, it is recommended to install the projector in a location that does not block ventilation. As an example, do not place the projector on a crowded coffee table, sofa, bed, etc. Do not put the projector in an enclosure such as a book case or a cabinet that restricts air flow.
2. Do not use the projector near water or moisture. To reduce the risk of fire and/or electric shock, do not expose the projector to rain or moisture.
3. Do not install near heat sources such as radiators, heaters, stoves or any other apparatus such as amplifiers that emits heat.
4. Clean only with dry cloth.
5. Only use attachments/accessories specified by the manufacturer.
6. Do not use the unit if it has been physically damaged or abused. Physical damage/abuse would be (but not limited to):
 - Unit has been dropped.
 - Power supply cord or plug has been damaged.
 - Liquid has been spilled on to the projector.
 - Projector has been exposed to rain or moisture.
 - Something has fallen in the projector or something is loose inside.Do not attempt to service the unit yourself. Opening or removing covers may expose you to dangerous voltages or other hazards. Please call Optoma before you send the unit for repair.
7. Do not let objects or liquids enter the projector. They may touch dangerous voltage points and short out parts that could result in fire or electric shock.
8. See projector enclosure for safety related markings.
9. The unit should only be repaired by appropriate service personnel.

Usage Notice

Precautions



Please follow all warnings, precautions and maintenance as recommended in this user's guide.

- ■ Warning- Do not look into the projector's lens when the LED is on. The bright light may hurt your eyes.
- ■ Warning- To reduce the risk of fire or electric shock, do not expose this projector to rain or moisture.
- ■ Warning- Please do not open or disassemble the projector as this may cause electric shock.
- ■ Warning- When switching the projector off, please ensure the cooling cycle has been completed before disconnecting power. Allow 10 seconds for the projector to cool down.
- ■ Warning- Do not use lens cap when projector is in operation.
- ■ Warning- Allowing the proper amount of space on the top, sides, and rear of the projector cabinet is critical for proper air circulation and cooling of the unit. The dimensions shown here indicate the minimum space required. If the projector is to be built into a compartment or similarly enclosed, these minimum distances must be maintained.

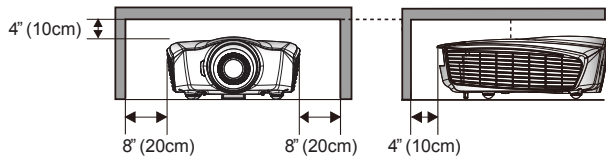

Usage Notice

Do:

- ❖ Turn off and unplug the power plug from the AC outlet before cleaning the product.
- ❖ Use a soft dry cloth with mild detergent to clean the display housing.
- ❖ Disconnect the power plug from AC outlet if the product is not being used for a long period of time.

Do not:

- ❖ Block the slots and openings on the unit provided for ventilation.
- ❖ Use abrasive cleaners, waxes or solvents to clean the unit.
- ❖ Use under the following conditions:
 - In extremely hot, cold or humid environments.
 - ▶ Ensure that the ambient room temperature is within 5°C ~ 40°C
 - ▶ Relative humidity is 10% ~ 85%
 - In areas susceptible to excessive dust and dirt.
 - Near any appliance generating a strong magnetic field.
 - In direct sunlight.

Viewing 3D projection using the 3D function

IMPORTANT SAFETY INFORMATION. READ THE FOLLOWING WARNINGS BEFORE YOU OR YOUR CHILD USE THE 3D FUNCTION.

Warning

- ❖ Children and teenagers may be more susceptible to health issues associated with viewing in 3D and should be closely supervised when viewing these images.

Photosensitive Seizure Warning and Other Health Risks

- ❖ Some viewers may experience an epileptic seizure or stroke when exposed to certain flashing images or lights contained in certain Projector pictures or video games. If you suffer from, or have a family history of epilepsy or strokes, please consult with a medical specialist before using the 3D function.
- ❖ Even those without a personal or family history of epilepsy or stroke may have an undiagnosed condition that can cause photosensitive epileptic seizures.
- ❖ Pregnant women, the elderly, sufferers of serious medical condi-

Usage Notice

- tions, those who are sleep deprived or under the influence of alcohol should avoid utilizing the unit's 3D functionality.
- ❖ If you experience any of the following symptoms, stop viewing 3D pictures immediately and consult a medical specialist: (1) altered vision; (2) light-headedness; (3) dizziness; (4) involuntary movements such as eye or muscle twitching; (5) confusion; (6) nausea; (7) loss of awareness; (8) convulsions; (9) cramps; and/ or (10) disorientation. Children and teenagers may be more likely than adults to experience these symptoms. Parents should monitor their children and ask whether they are experiencing these symptoms.
 - ❖ Watching 3D projection may also cause motion sickness, perceptual after effects, disorientation, eye strain and decreased postural stability. It is recommended that users take frequent breaks to lessen the potential of these effects. If your eyes show signs of fatigue or dryness or if you have any of the above symptoms, immediately discontinue use of this device and do not resume using it for at least thirty minutes after the symptoms have subsided.
 - ❖ Watching 3D projection while sitting too close to the screen for an extended period of time may damage your eyesight. The ideal viewing distance should be at least three times the screen height. It is recommended that the viewer's eyes are level with the screen.
 - ❖ Watching 3D projection while wearing 3D glasses for an extended period of time may cause a headache or fatigue. If you experience a headache, fatigue or dizziness, stop viewing the 3D projection and rest.
 - ❖ Do not use the 3D glasses for any other purpose than for watching 3D projection. Wearing the 3D glasses for any other purpose (as general spectacles, sunglasses, protective goggles, etc.) may be physically harmful to you and may weaken your eyesight.
 - ❖ Viewing in 3D projection may cause disorientation for some viewers. Accordingly, DO NOT place your 3D PROJECTOR near open stairwells, cables, balconies, or other objects that can be tripped over, run into, knocked down, broken or fallen over.

Eye Safety Warnings



- ■ Avoid staring/facing directly into the projector beam at all times. Keep your back to the beam as much as possible.
- ■ When projector is used in a classroom, adequately supervise students when they are asked to point out something on the screen.
- ■ In order to minimize the lamp power, use room blinds to reduce ambient light levels.

Flexible Angle Setting

- ■ Available angle in vertical direction

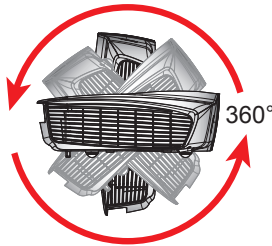

- ■ Available angle in horizontal direction

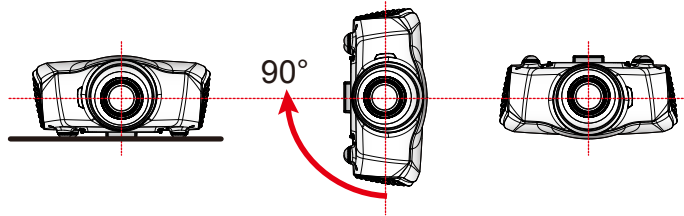

Introduction

Package Overview

Unpack and inspect the box contents to ensure all parts listed below are in the box. If something is missing, please contact Optoma customer service.

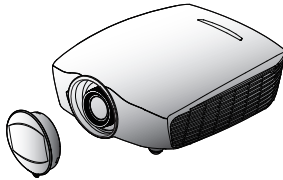

Projector with lens cap

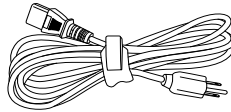

Power Cord

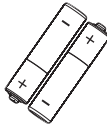

2 × AA Batteries



IR Remote Control
(Remote may vary depending on model)



❖ Due to different applications in each Country, some regions may have different accessories.

Documentation :

- Warranty Card
- Quick Start Card
- WEEE Card
(for EMEA only)



❖ For European warranty information please visit www.optomaeurope.com

Introduction

Product Overview

Main Unit

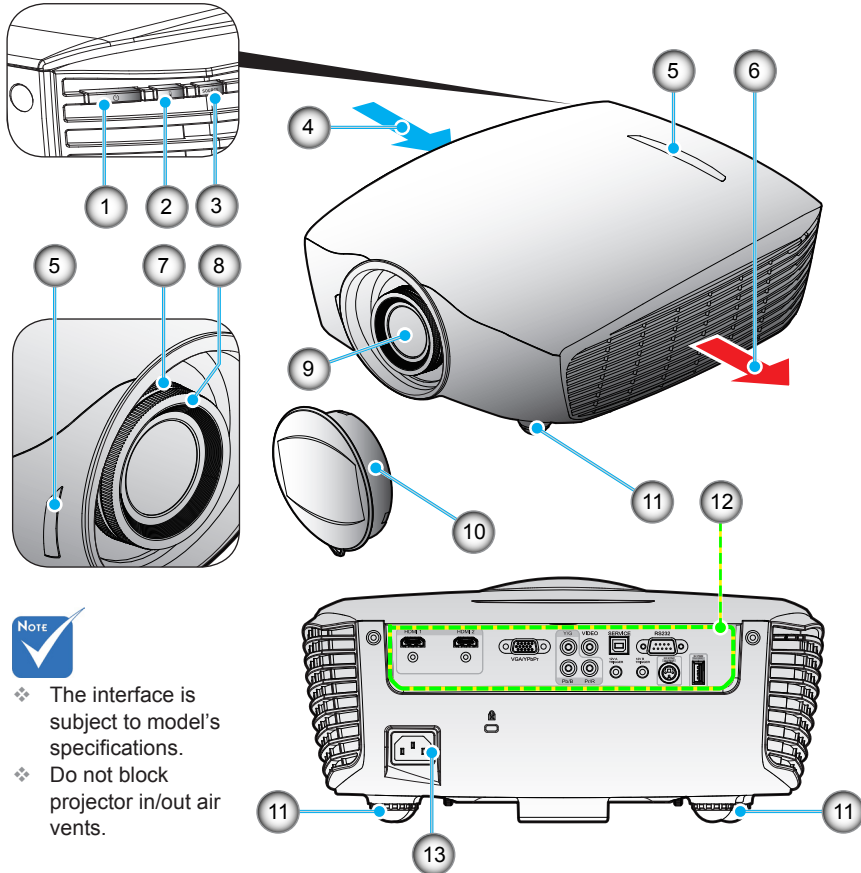

NOTE

- ❖ The interface is subject to model's specifications.
- ❖ Do not block projector in/out air vents.

- | | |
|-----------------------------|--------------------------------|
| 1. Power Button / Power LED | 7. Zoom Ring |
| 2. Temp LED | 8. Focus Ring |
| 3. Source Button | 9. Lens |
| 4. Ventilation (inlet) | 10. Lens Cap |
| 5. IR Receivers | 11. Tilt-Adjustment Feet |
| 6. Ventilation (outlet) | 12. Input / Output Connections |
| | 13. Power Socket |

Introduction

Input/Output Connections

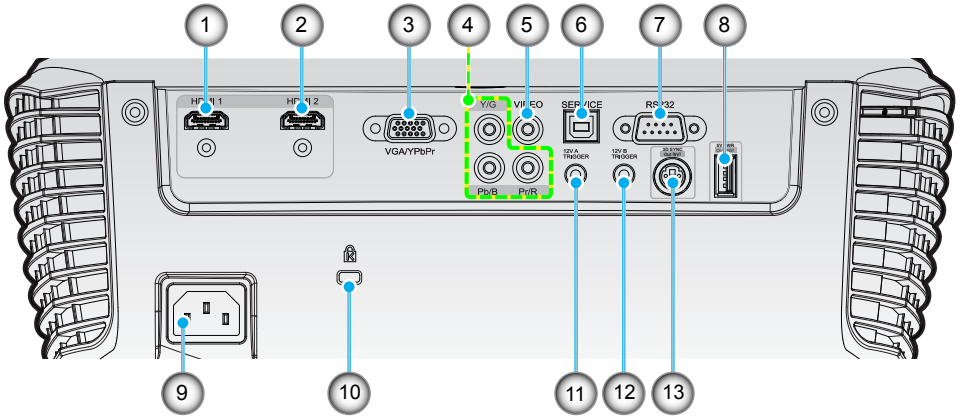

1. HDMI 1 Connector (v1.4a 3D supported)
2. HDMI 2 Connector (v1.4a 3D supported)
3. VGA-In/YPbPr Connector
(PC Analog Signal/Component Video Input/HDTV/YPbPr)
4. Component Video Input Connector (YPbPr)
5. Composite Video Input Connector
6. USB for firmware upgrade
7. RS-232 Connector (9-pin)
8. USB for Power (5V@1A)
9. Power Socket
10. Kensington™ Lock Port
11. 12V Trigger A Relay Connector (12V, 250mA. 3.5mm Mini Jack)
12. 12V Trigger B Relay Connector (12V, 250mA. 3.5mm Mini Jack)
13. 3D Sync Out (5V)



❖ The interface is subject to model's specifications.

Introduction

Remote Control



❖ The remote is subject to model's specifications.

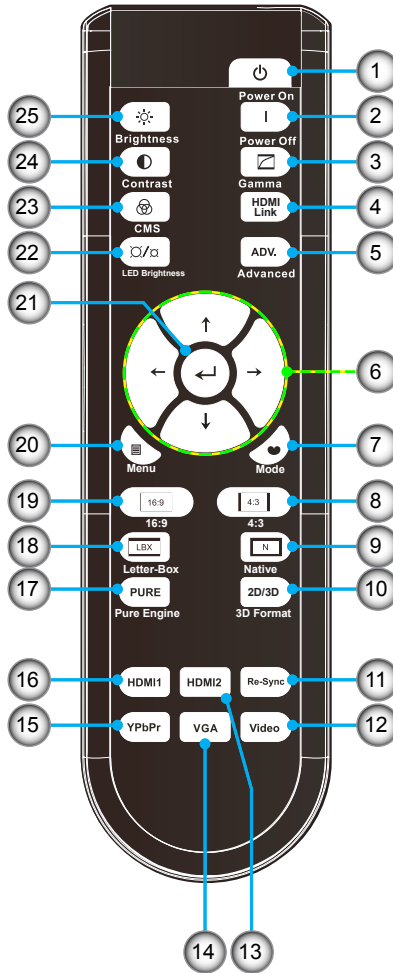

1. Power On
2. Power Off
3. Gamma
4. HDMI Link
5. Advanced
6. Four Directional Select Keys
7. Mode
8. 4:3
9. Native
10. 3D format
11. Re-Sync
12. Video Source
13. HDMI2 Source
14. VGA Source
15. YPbPr Source
16. HDMI1 Source
17. PureEngine
18. LBX
19. 16:9
20. Menu
21. Enter
22. LED Brightness
23. CMS (Color Management System)
24. Contrast
25. Brightness

Installation

Connecting the Projector

Connect to Computer/Notebook

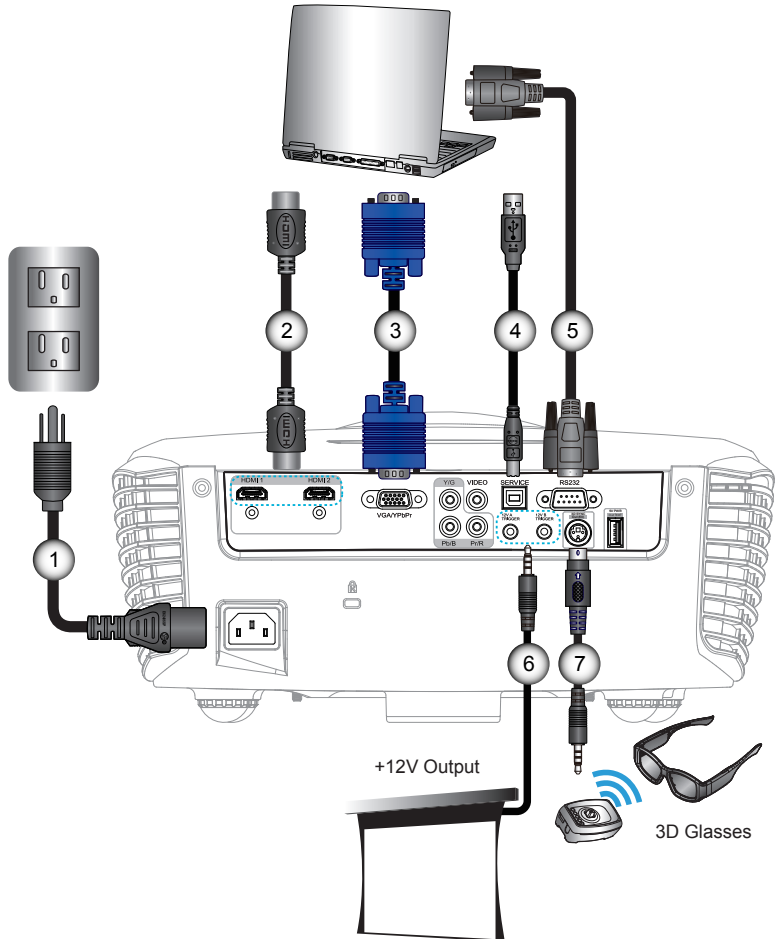

- ❖ Due to the difference in applications for each country, some regions may have different accessories.
- ❖ (*) Optional accessory

| | |
|--------|-------------------|
| 1..... | Power Cord |
| 2..... | *HDMI Cable |
| 3..... | *VGA Cable |
| 4..... | *USB Cable |
| 5..... | *RS232 Cable |
| 6..... | *12V DC Jack |
| 7..... | *3D Emitter cable |

Installation

Connect to Video Sources

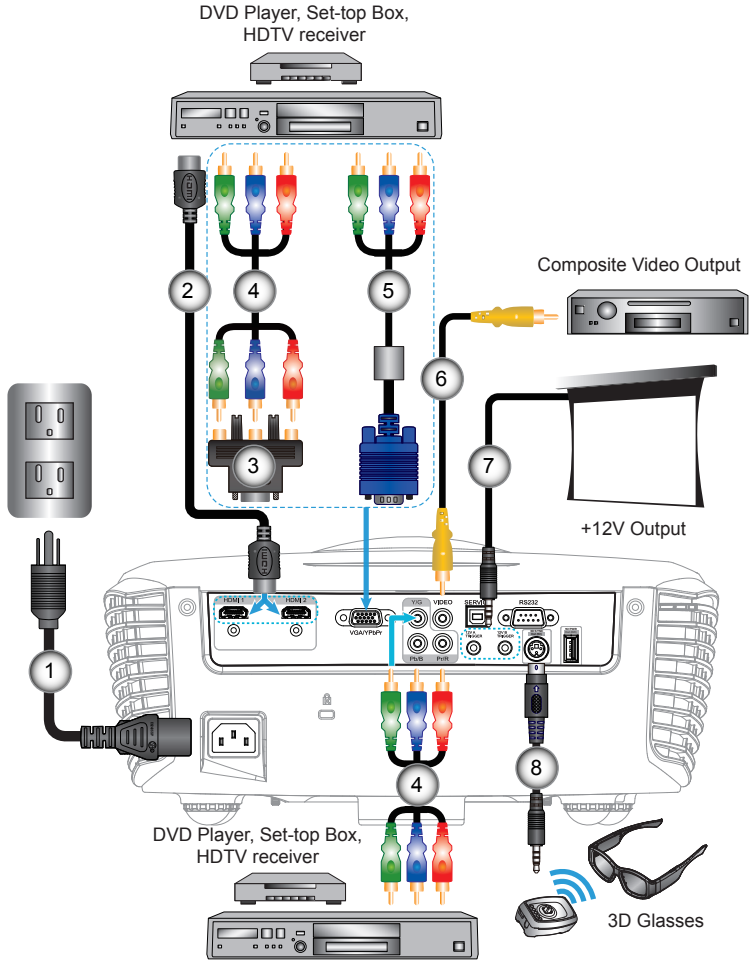

- ❖ Due to the difference in applications for each country, some regions may have different accessories.
- ❖ For more detailed information about connecting to the 3D emitter and 3D glasses, please refer to their user's guides.
- ❖ Use high speed HDMI cable to connect Blu-ray 3D player.
- ❖ (*) Optional Accessory

| | |
|--------|------------------------|
| 1..... | Power Cord |
| 2..... | *HDMI Cable |
| 3..... | *VGA/RCA Adaptor |
| 4..... | *3 RCA Component Cable |
| 5..... | *VGA/RCA Cable |
| 6..... | *Composite Video Cable |
| 7..... | *12V DC Jack |
| 8..... | *3D Emitter cable |

Connect to 3D Video Devices



- ❖ The 3D video source device must be powered on before the 3D projector.

Once you have connected your devices together with HDMI cables, as shown in the diagram, you are ready to begin. **Power ON your 3D video source and your 3D projector.**

PlayStation® 3 Games

- Make sure that you have updated your console to the latest software version.
- Go to the “Settings menu -> Display settings -> Video output -> HDMI”. Select “Automatic” and follow the on-screen instructions.
- Insert your 3D game disc. Alternatively you can download games (and 3D updates) via the PlayStation® network.
- Launch the game. In the in-game menu, select “Play in 3D”.

Blu-ray 3D™ Player

- Make sure that your player can support 3D Blu-ray™ disc and that 3D output is enabled.
- Insert the 3D Blu-ray™ disc into the player, press “Play”.

3D TV (e.g. SKY 3D, DirecTV)

- Contact your TV service provider to enable any 3D channels on your channel package.
- Once enabled, switch to the 3D channel.
- You should see two images side-by-side.
- Switch to the “SBS Mode” of the 3D projector. The option is located in the “DISPLAY” section of the projector OSD menu.

3D Device (e.g. 3D DV/DC) with 2D 1080i side by side signal output

- Connect your 3D device and switch to out 3D content with 2D side-by-side output to 3D Projector.
 - You should see two images side-by-side.
- Switch to the “SBS Mode” of the 3D projector. The option is located in the “DISPLAY” section of the projector OSD menu.

If watching 3D content from an HDMI 1.4a source (e.g. 3D Blu-ray) your 3D glasses should always be in sync. If watching 3D content from an HDMI 1.3 source (e.g. 3D broadcast using SBS mode) it may be necessary to use the projector’s 3D Sync-Invert option to optimize your 3D experience. The option is located in the “DISPLAY ->3D” section of the projector OSD menu.



- ❖ If input video is normal 2D, please press “3D Format” and switch to “AUTO”.
- ❖ If “SBS Mode” is active, 2D video content will not display correctly.

Installation





❖ For more detailed information, please refer to 3D glasses user's guide.

Using the 3D glasses

1. To turn ON 3D glasses: Press the "Power" button and the LED will flash one time indicating the glasses are ready to use 3D mode.
2. Verify that 3D content is being sent to the projector and signal is compatible with projector specifications.
3. Turn on the "3D Mode" of the 3D projector. The option is located in the "DISPLAY" section of the projector OSD menu.
4. Turn on 3D glasses and verify image appears in 3D without eyestrain.
5. If the image does not appear in 3D, please check 3D device set up correctly to send out 3D image or not. Or "SBS Mode" should turn on when input signal is 2D 1080i side-by-side and repeat previous steps 1 ~ 4.
6. It may be necessary to use projector's "3D Sync. Invert" option to optimize your 3D experience. The option is located in the "DISPLAY" section of the projector OSD menu.
7. To turn OFF 3D glasses: Press the "Power" button and hold until the LED switches off.
8. For more detailed information, please refer to the 3D glasses user's guide, or manufacturer's Website.

Powering On/Off the Projector

Powering On the Projector

1. Remove the lens cap. ❶
2. Securely connect the power cord and signal cable. When connected, the Power LED will turn red.
3. Turn on the projector by pressing “**⏻**” button either on the side of the projector or on the remote. The Power LED will now turn blue. ❷
The startup screen will display in approximately 10 seconds. The first time you use the projector, you will be asked to select the preferred language.
4. Turn on and connect the source that you want to display on the screen (computer, notebook, video player, etc). The projector will detect the source automatically. If not, push menu button and go to “SETUP”. Make sure that the “Source Lock” has been set to “Off”.
 - ❖ If you connect multiple sources at the same time, press the “SOURCE” button on the control panel or the direct source keys on the remote control to switch between inputs.



- ❖ Turn on the projector first and then select the signal sources.

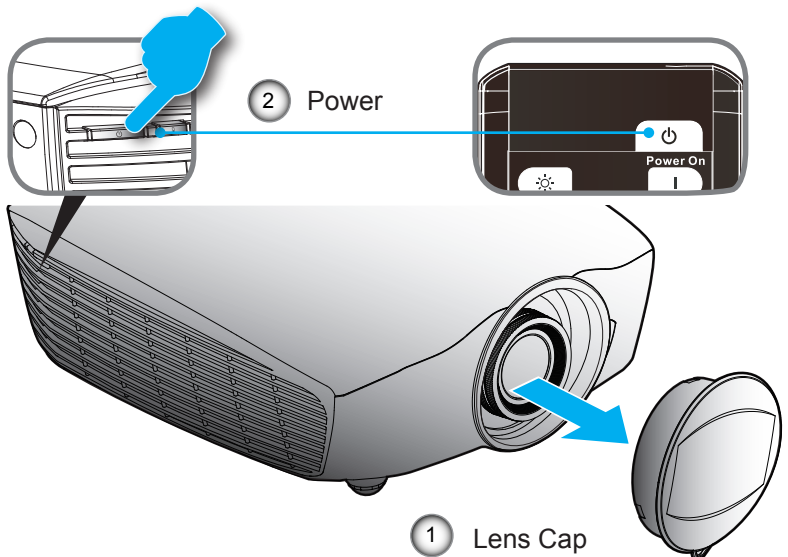

Powering Off the Projector

1. Press the “I” button on the remote control or “⏻” button on the side of the projector two times with one second interval to turn off the projector. The following message will be displayed on the screen.

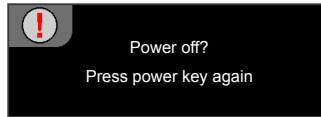

Press the “I” button again to confirm otherwise the message will disappear after 15 seconds. When you press the “I” button for the second time, the projector will shut down.

2. The cooling fans continue to operate for about 10 seconds for cooling cycle and the Power LED will flash blue. When the Power LED lights solid red, the projector has entered standby mode.
If you wish to turn the projector back on, you must wait until the projector has completed the cooling cycle and has entered standby mode. Once in standby mode, simply press “⏻” button to restart the projector.
3. Disconnect the power cord from the electrical outlet and the projector.
4. Do not turn on the projector immediately following a power off procedure.



❖ Contact the nearest service center if the projector displays these symptoms. See pages 61-62 for more information.

Warning Indicator

When the warning indicators (see below) come on, the projector will automatically shutdown:

- ❖ “Power” LED indicator flashes red.
- ❖ “TEMP” LED indicator is lit red and if “Power” LED indicator flashes red. This indicates the projector has overheated. Under normal conditions, the projector can be switched back on.
- ❖ “TEMP” LED indicator flashes red and if “Power” LED indicator flashes red.

Unplug the power cord from the projector, wait for 30 seconds and try again. If the warning indicator light up again, please contact your nearest service center for assistance.

Adjusting the Projected Image

Adjusting the Projector's Height

The projector is equipped with elevator feet for adjusting the image height.

1. Locate the adjustable foot you wish to modify on the underside of the projector.
2. Rotate the adjustable ring clockwise to raise the projector or counter clockwise to lower it. Repeat with the remaining feet as needed.

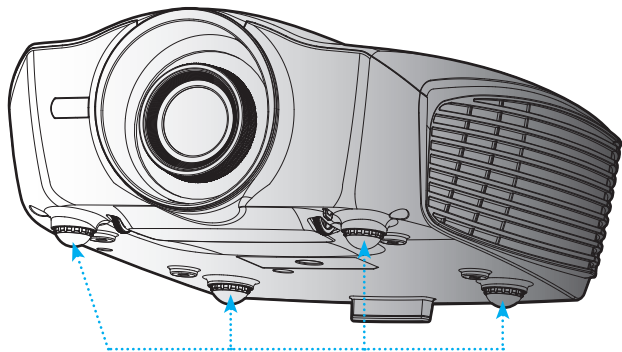

Tilt-Adjustment Feet

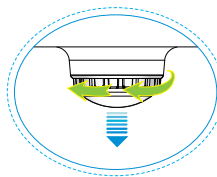

Tilt-Adjustment Ring

Installation

Adjusting the Projector's Position

To determine where to position the projector, consider the size and shape of your screen, the location of your power outlets, and the distance between the projector and the rest of your equipment.

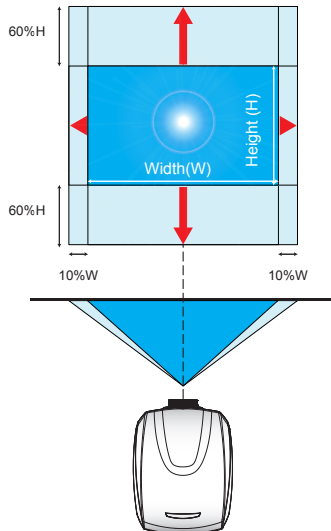
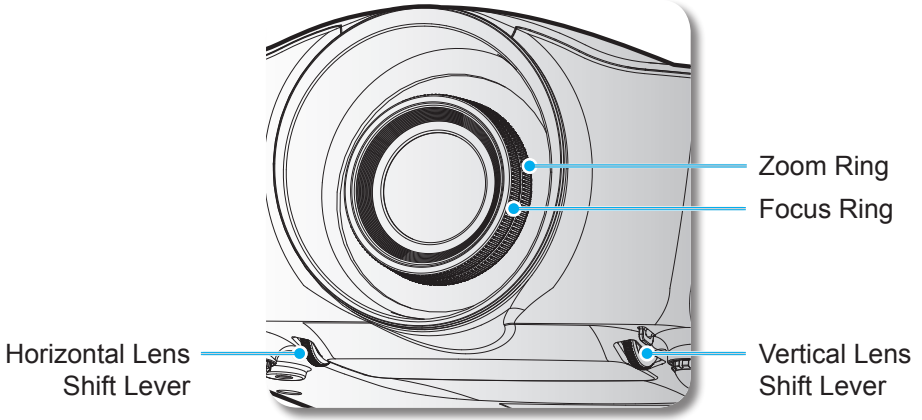

Installation



❖ This table is for user's reference only.

Lens

| Optoma Model Name | Wide version | Tele Version |
|-------------------------|--|--------------|
| Focal Length (f) (mm) | 18.07~22.59 | 22.56~42.87 |
| F number | 2.0~2.32 | 2.3~3.39 |
| Zoom Range (Ratio) | 1.25 | 1.90 |
| Zoom & Focus Adjustment | Manual | |
| Optical Lens Shift | Horizontal : +/-10%, Vertical : +/-60% | |



❖ Projection distance:
From screen to lens.



| Screen size (inch) | Wide version | | Tele Version | |
|-----------------------|--------------------------|-------|--------------|-------|
| | Projection Distance (mm) | | | |
| | Wide | Tele | Wide | Tele |
| 40 | 1065 | 1335 | 1310 | 2555 |
| 50 | 1335 | 1680 | 1650 | 3205 |
| 60 | 1610 | 2020 | 1995 | 3860 |
| 70 | 1885 | 2365 | 2335 | 4510 |
| 80 | 2160 | 2705 | 2680 | 5165 |
| 90 | 2430 | 3045 | 3020 | 5815 |
| 100 | 2705 | 3390 | 3365 | 6470 |
| 150 | 4075 | 5100 | 5080 | 9730 |
| 180 | 4901 | 6137 | 6105 | 11684 |
| 200 | 5445 | 6810 | 6790 | 12995 |
| 250 | 6810 | 8520 | 8505 | 16255 |
| 300 | 8180 | 10230 | 10215 | 19520 |
| 350 | 9550 | 11940 | 11930 | 22780 |
| 400 | 10920 | 13650 | 13640 | 26040 |
| 450 | 12285 | 15360 | 15350 | 29305 |
| 500 | 13655 | 17070 | 17065 | 32565 |

Control Panel & Remote Control

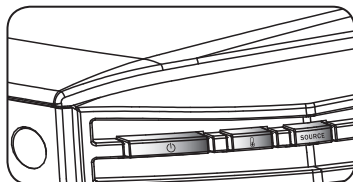
Control Panel



Using the Control Panel

| | | |
|----------------|---|---|
| Power Button / |  | Refer to the "Power On/Off the Projector" section on pages 16-17. |
| Power LED | | Indicate the projector's status. |
| Temp LED |  | Indicate the projector's temperature status. |
| SOURCE | | Press "SOURCE" to select an input signal. |

Remote Control

Installing Batteries

Two size AA batteries are supplied for Remote Control.

Replace only with the same or equivalent type recommended by the manufacturer.

CAUTION

Improper use of batteries can result in chemical leakage or explosion. Be sure to follow the instructions below.

- Do not mix batteries of different types. Different types of batteries have different characteristics.
- Do not mix old and new batteries. Mixing old and new batteries can shorten the life of new batteries or cause chemical leakage in old batteries.
- Remove batteries as soon as they are worn out. Chemicals that leak from batteries that come in contact with skin can cause a rash. If you find any chemical leakage, wipe thoroughly with a cloth.
- The batteries supplied with this product may have a shorter life expectancy due to storage conditions.
- If you will not be using the remote control unit for an extended period of time, remove batteries from it.
- When you dispose of the battery, you must obey the law in the relative area or country.

User Controls

Remote Control

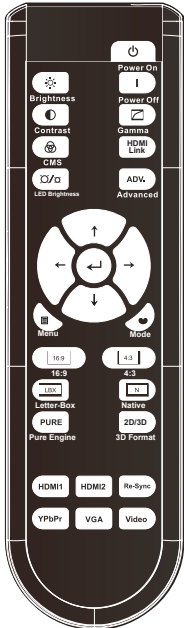

Using the Remote Control

| | | |
|------------------------------|-------|---|
| Power On | | Turn on the projector. |
| Power Off | | Turn off the projector. |
| Gamma | | Set up gamma curve type. |
| HDMI Link | | Enables and disables the HDMI link function. |
| Advanced | ADV. | Display or exit the "IMAGE Advanced" menu. |
| Four Directional Select Keys | | Use directional select keys to select items or make adjustments to your selection. |
| Mode | | Select a display mode for optimised settings for different applications. (refer to page 28) |
| 4:3 | | Scale the image at a 4:3 (1440x1080) aspect ratio. |
| Native | | The input source will be displayed without scaling. |
| 3D Format | 2D/3D | Manually select a 3D mode that matches your 3D content. |
| Re-Sync | | Automatically synchronizes the projector to the input source. |
| Video | | Press "Video" to choose Composite video source. |
| HDMI2 | | Press "HDMI2" to choose source from HDMI 2 connector. |
| VGA | | Press "VGA" to choose source from VGA-In/YPbPr connector. |
| YPbPr | | Press "YPbPr" to choose source from YPbPr connector. |

User Controls

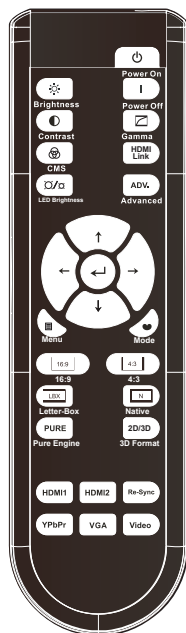

Using the Remote Control

| | | |
|-------------------------------|------|---|
| HDMI1 | | Press "HDMI1" to choose source from HDMI 1 connector. |
| PureEngine | PURE | The PureEngine is a collection of advanced image processing technologies that enhances the quality of the displayed image. |
| LBX | LBX | Enable the viewing of the letterboxed nonanamorphically enhanced movie at full screen width. Part of the original image will be lost if the image aspect ratio is less than 2.35:1. |
| 16:9 | 16:9 | Scale the image at a 16:9 (1920x1080) aspect ratio. |
| Menu | ≡ | Display or exit the on-screen display menus for projector. |
| Enter | ↵ | Confirm your item selection. |
| LED Brightness | ☉/☽ | Increase/Decrease the luminance of the image. (refer to page 30) |
| CMS (Color Management System) | ⊗ | Select one of the colors (R/G/B/ C/M/Y) to adjust its x/y offset and brightness. |
| Contrast | ◐ | Control the degree of difference between the lightest and darkest parts of the picture. |
| Brightness | ☀ | Adjust the brightness of the image. |

On-screen Display Menus

The Projector has multilingual On-screen Display menus that allow you to make image adjustments and change a variety of settings. The projector will automatically detect the source.

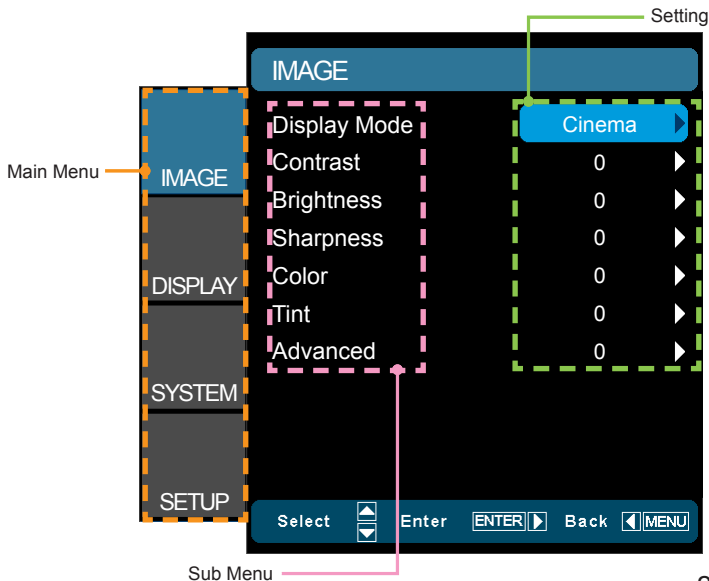

How to operate

1. To open the OSD menu, press “Menu” on the Remote Control or Control Panel.
2. When OSD is displayed, use ▲▼ keys to select any item in the main menu. While making a selection on a particular page, press ► or “Enter” key to enter sub menu.
3. Use ▲▼ keys to select the desired item in the sub menu and then press ► or “Enter” key to view further settings. Adjust the settings by ◀▶ key.
4. Select the next item to be adjusted in the sub menu and adjust as described above.
5. Press “Enter” or “Menu” to confirm, and the screen will return to the main menu.
6. To exit, press “Menu” again. The OSD menu will close and the projector will automatically save the new settings.



User Controls

Menu Tree

| Main Menu | Sub Menu | Settings | |
|-----------------|------------------------|---|---|
| IMAGE | Display Mode | Cinema / Film / Reference / Photo / Bright / 3D / ISF Day / ISF Night / User | |
| | Contrast | -50~50 | |
| | Brightness | -50~50 | |
| | Sharpness | 0~15 | |
| | #1 Color | -50~50 | |
| | #1 Tint | -50~50 | |
| | Advanced | Noise Reduction | 0~10 |
| | | Gamma | Film / Video / Graphics / Standard |
| | | PureEngine | UltraDetail / PureColor / PureMotion / PureEngine Demo / Exit |
| | | LED Brightness | Power / DynamicBlack 1 / DynamicBlack 2 / DynamicBlack 3 |
| | | Color Settings | Color Temperature / Color Gamut / CMS / RGB Gain/Bias / Color Space / RGB Channel |
| | | Exit | |
| | DISPLAY | Format | 4:3 / 16:9 / LBX / Native / Auto235 / Auto235_Subtitle |
| | | Zoom | 0~10 |
| | | Edge Mask | 0~5 |
| Image Shift | | H | -100~100 |
| | | V | -100~100 |
| V Keystone | | -30~30 | |
| 3D | | 3D Format | AUTO / SBS / Top and Bottom / Frame Sequential / 2D->3D |
| | | 3D -> 2D | 3D / L / R |
| | | 2D->3D | Low / Middle / High |
| | | #2 3D Sync. Invert | On / Off |
| Exit | | | |
| SYSTEM | Menu Location |  | |
| | LED Hours | | |
| | Projection |  | |
| | Test Pattern | Off / Grid / White | |
| | Background Color | Blue / Gray / Black | |
| | IR Function | All / Front / Top | |
| | 12V Trigger A | On / Off | |
| | 12V Trigger B | Off | |
| | | On | 4:3 / 16:9 / LBX / Native / Exit |
| | | Auto 3D | |
| Exit | | | |
| Anamorphic Lens | None / Fixed / Movable | | |

User Controls

| Main Menu | Sub Menu | Settings | | |
|-----------|--------------------|---|----------------------------------|--------------|
| SETUP | Language | English / Deutsch / Français / Italiano / Español / Português / Svenska / Nederlands / Norsk / Dansk / Polski / Suomi / Русский / ελληνική / Magyar / Čeština / عربي / 繁體中文 / 简体中文 / 日本語 / 한국어 / Türkçe / ไทย | | |
| | Input Source | HDMI 1 / HDMI 2 / Component / VGA / Video / Exit | | |
| | HDMI Link Settings | HDMI Link | On / Off | |
| | | Inclusive of TV | Yes / No | |
| | | Power On Link | Mutual/PJ -> Device/Device -> PJ | |
| | | Power Off Link | On / Off | |
| | Source Lock | On / Off | | |
| | High Altitude | On / Off | | |
| | Information Hide | On / Off | | |
| | Auto Power Off | 0~180 | | |
| | Signal | Frequency | 0~100 | |
| | | Phase | -50~50 | |
| | | H. Position | -50~50 | |
| | | V. Position | -50~50 | |
| | | Automatic | Enable / Disable | |
| | | Exit | | |
| | | White Level | -50~50 | |
| | | Black Level | -50~50 | |
| | | Saturation | -50~50 | |
| | | Hue | -50~50 | |
| | | IRE | 0 IRE / 7.5 IRE | |
| | | Exit | | |
| | | Reset | Current | Cancel / Yes |
| | | | All | Cancel / Yes |



- ❖ Please note that the on-screen display (OSD) menus vary according to the signal type selected and the projector model you are using.
- ❖ (#1) “Color” and “Tint” are only supported in Video mode.
- ❖ (#2) “3D Sync Invert” is only available when 3D is enabled.

IMAGE

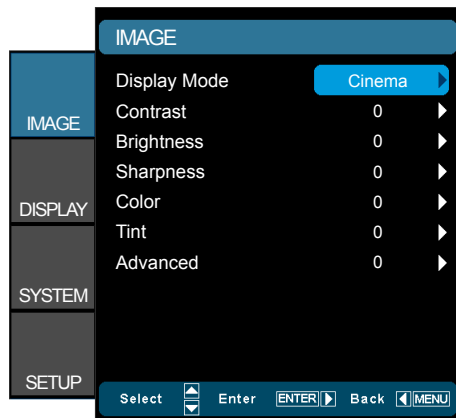

Display Mode

There are many factory presets optimized for various types of images.

- ▶ Cinema: Default settings for home theater.
- ▶ Reference: This mode is intended to reproduce, as close as possible, the image the way the movie director intended. Color, color temperature, brightness, contrast and gamma settings are all configured to standard reference levels.
- ▶ Film: The purest color settings for home theater.
- ▶ Photo: Optimized for displaying photographic images.
- ▶ Bright: Maximum brightness from PC input.
- ▶ 3D: Recommended setting for 3D mode enabled. Any further adjustments by the user in 3D will be saved in this mode for further use.
- ▶ ISF Day: Optimize the image with the ISF Day mode to be perfectly calibrated and high picture quality.
- ▶ ISF Night: Optimize the image with the ISF Night mode to be perfectly calibrated and high picture quality.
- ▶ User: User's settings.

Contrast

The contrast controls the degree of difference between the lightest and darkest parts of the picture.

- ▶ Press the ◀ to decrease the contrast.
- ▶ Press the ▶ to increase the contrast.

Brightness

Adjust the brightness of the image.

- ▶ Press the ◀ to darken image.
- ▶ Press the ▶ to lighten the image.

Sharpness

Adjust the sharpness of the image.



- ❖ "ISF Day" and "ISF Night" will not be shown when the ISF modes have not been calibrated.

User Controls

- ▶ Press the ◀ to decrease the sharpness.
- ▶ Press the ▶ to increase the sharpness.

Color

Adjust a video image from black and white to fully saturated color.

- ▶ Press the ◀ to decrease the color saturation in the image.
- ▶ Press the ▶ to increase the color saturation in the image.

Tint

Adjust the color balance of red and green.

- ▶ Press the ◀ to increase the amount of green in the image.
- ▶ Press the ▶ to increase the amount of red in the image.



- ❖ “Color” and “Tint” are only supported for composite and component sources.

IMAGE | Advanced

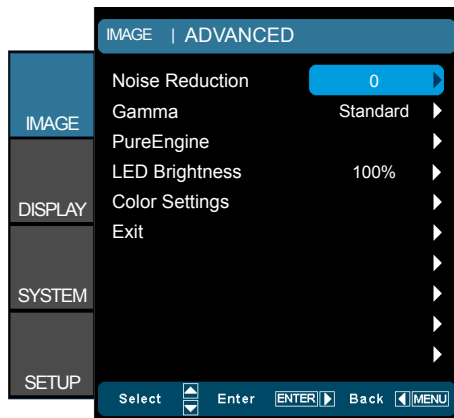

Noise Reduction

The Noise Reduction reduces the amount of visible noise inter-laced signals. The range is from “0” to “10”. (0: Off)

Gamma

This allows you to set up gamma curve type. After the initial setup and fine tuning is completed, utilize the Gamma Adjustment steps to optimize your image output.

- ▶ Film: for home theater.
- ▶ Video: for video or TV source.
- ▶ Standard: for standardized setting.
- ▶ Graphics: for PC / Photo source.

PureEngine

The PureEngine is a collection of advanced image processing technologies that enhances the quality of the displayed image.

LED Brightness

- ▶ Power: Manually adjust the LED brightness (100%~50%).
- ▶ DynamicBlack 1: Automatically adjusts the LED brightness between 100% ~ 13%.
- ▶ DynamicBlack 2: Automatically adjusts the LED brightness between 100% ~ 5%.
- ▶ DynamicBlack 3: Automatically adjusts the LED brightness between 100% ~ 0%.

Color Settings

Press ▶ into the next menu and then use ▲ or ▼ to select item.

IMAGE | Advanced | PureEngine

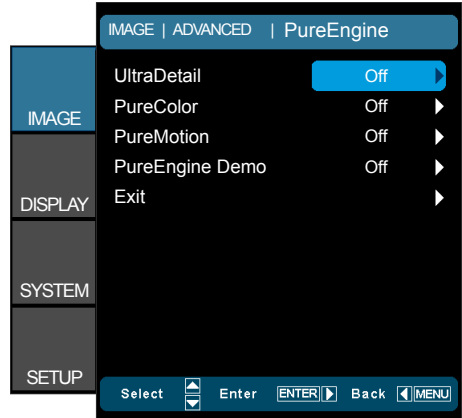

UltraDetail

UltraDetail is an edge enhancement tool that enables the edges in the projected image to be enhanced, thus providing more perceived detail.

PureColor

This adjustable item utilizes a new color-processing algorithm and enhancements to enable the picture's vividness to be significantly increased. The range is from "0" to "5".

PureMotion

PureMotion uses sophisticated algorithms to ensure that the natural motion in the image is preserved.

PureEngine Demo

This feature enables you to see the difference in the image quality between the raw unprocessed image and the image processed as processed by the PureEngine. Use this mode to check the adjustments that you make to the PureEngine settings.



- ❖ Turn the PureMotion feature to "Off" to reduce the response lag during gameplay.

IMAGE | Advanced | Color Settings

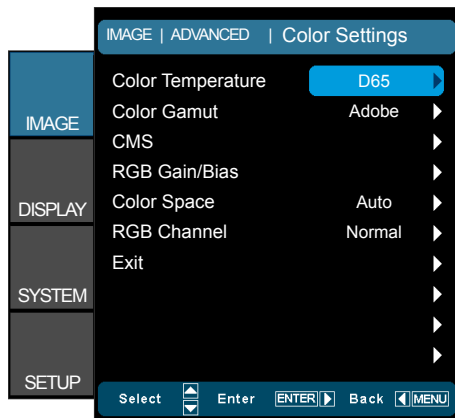

Color Temperature

Select a color temperature from D50, D65, D75, D83, D93 and Native.

Color Gamut

Select an appropriate color gamut from Native, Adobe, DLP-C, HDTV, or SMPTE-C.

CMS (Color Management System)

Press ► into the next menu and then use ▲ or ▼ to select item. Select one of the colors (R/G/B/C/M/Y) to adjust its x/y offset and brightness.

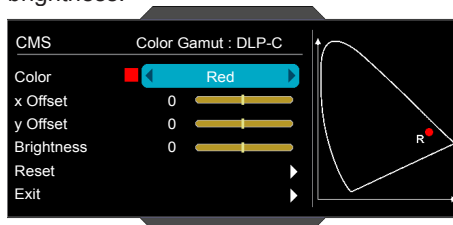

- ▶ Color: Use ◀ or ▶ to select from Red, Green, Blue, Cyan, Magenta or Yellow colors.
- ▶ x Offset: Use ◀ or ▶ to adjust the x offset value of selected color.
- ▶ y Offset: Use ◀ or ▶ to adjust the y offset value of selected color.
- ▶ Brightness: Use ◀ or ▶ to adjust the brightness value of selected color.
- ▶ Reset: Choose "Yes" to return the factory default settings for color adjustments.

User Controls

RGB Gain/Bias

Press ► into the next menu and then use ▲ or ▼ to select item.

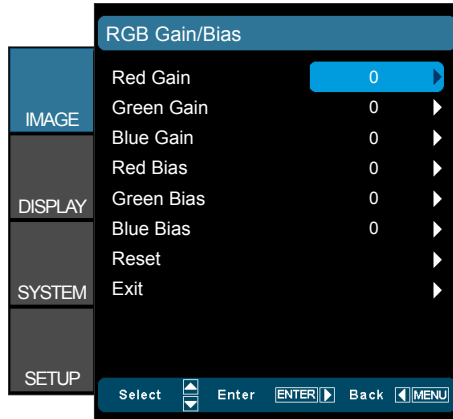

- ▶ Use ◀ or ► to select Red, Green, or Blue for brightness (Gain) and contrast (Bias).
- ▶ Reset: Choose “Yes” to return the factory default settings for color adjustments.

Color Space

Select an appropriate color matrix type from AUTO, RGB(0-255), RGB(16-235) or YUV.

RGB Channel

Use ◀ or ► to select from Normal, Red, Green or Blue channels.

DISPLAY

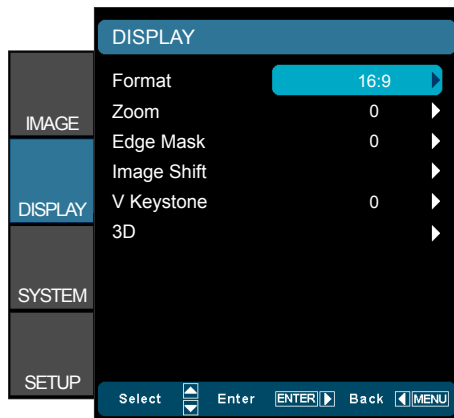

- ❖ (#1) This function is not supported in the movable or fixed of anamorphic lens.
 - ❖ (#2) This function is only supported when System/Anamorphic Lens is Fixed or Movable.
- When Auto235 feature is selected the 12v trigger will send power to the anamorphic lens if the source format is 2.35:1. It will not send the power when the source format is 4:3 or 16:9.

Format

Use this function to choose your desired aspect ratio.

- ▶ 4:3: This format is for 4x3 input sources.
- ▶ 16:9: This format is for 16x9 input sources, like HDTV and DVD enhanced for Widescreen TV.
- ▶ LBX: This format is for non-16x9, letterbox source and for users who use external anamorphic lens to display 2.35:1 aspect ratio using full resolution.
- ▶ Native ^(#1): This format displays the original image without scaling.
- ▶ Auto235 ^(#2): Automatically selects the appropriate display format.
- ▶ Auto235_Subtitle ^(#2): Automatically selects the appropriate display format with subtitle.

| HDMI | Auto235 OFF | | | |
|----------------|-------------|------|-----|--------|
| | 4:3 | 16:9 | LBX | Native |
| 2D/HQFS/2D->3D | ✓ | ✓ | ✓ | ✓ |
| SBS | | ✓ | | |
| Top and Bottom | | ✓ | ✓ | |
| 1080p24FP | ✓ | ✓ | ✓ | ✓ |
| 720pFP | ✓ | ✓ | ✓ | |

User Controls

| HDMI | Auto235 ON | | | | |
|----------------|------------|------|-----|---------|------------------|
| | 4:3 | 16:9 | LBX | Auto235 | Auto235 subtitle |
| 2D/HQFS/2D->3D | ✓ | ✓ | ✓ | ✓ | ✓ |
| SBS | | ✓ | | | |
| Top and Bottom | | ✓ | ✓ | ✓ | ✓ |
| 1080p24FP | ✓ | ✓ | ✓ | ✓ | ✓ |
| 720pFP | ✓ | ✓ | ✓ | ✓ | ✓ |

| Component | Auto235 OFF | | | |
|----------------|-------------|------|-----|--------|
| | 4:3 | 16:9 | LBX | Native |
| 2D/HQFS/2D->3D | ✓ | ✓ | ✓ | ✓ |
| SBS | | ✓ | | |
| Top and Bottom | | ✓ | | |

| Component | Auto235 ON | | | | |
|----------------|------------|------|-----|---------|------------------|
| | 4:3 | 16:9 | LBX | Auto235 | Auto235 subtitle |
| 2D/HQFS/2D->3D | ✓ | ✓ | ✓ | ✓ | ✓ |
| SBS | | ✓ | | | |
| Top and Bottom | | ✓ | | | |



❖ Pressing "Native" button on the remote will be "Auto235" when Anamorphic lens is fixed or movable.

Detail informations about LBX mode:

1. Some Letter-Box Format DVDs are not enhanced for 16x9 TVs. In this situation, the image will not look right when displayed in 16:9 mode. In this situation, please try to use the 4:3 mode to view the DVD. If the content is not 4:3, there will be black bars around the image in 16:9 display. For this type of content, you can use LBX mode to fill the image on the 16:9 display.
2. If you use an external anamorphic lens, this LBX mode also allows you to watch a 2.35:1 content (include Anamorphic DVD and HDTV film source) that support anamorphic wide is enhanced for 16x9 Display in a wide 2.35:1 image. In this case, there are no black bars. LED power and vertical resolution are fully utilized.

User Controls



- ❖ (#1) This function is not supported in SBS mode.
- ❖ Pressing "Native" button on the remote will be "Auto235" when Anamorphic lens is fixed or movable.

| No anamorphic lens attached 1080p Scaling Table | | | | | |
|--|---|--------|---------|------|----|
| 16:9 Screen | 480i/p | 576i/p | 1080i/p | 720p | PC |
| 4:3 | 1440 x 1080 center | | | | |
| 16:9 | 1920 x 1080 center | | | | |
| LBX (#1) | 1920 x 1440 center, then get the central 1920 x 1080 image to display | | | | |
| Native | No resize image, 1:1 mapping and centered. This format shows original image without scaling. | | | | |
| Auto235 | If this format is select, Screen type will auto become 16:9 (1920x1080) If source is 4:3, auto resize to 1440 x1080 If source is 16:9 auto resize to 1920x1080 If source is 16:10 auto resize to 1920 x 1200 and cut 1920x1080 area to display | | | | |

| When anamorphic lens is movable | | | | | |
|---|---|------------------------------|-------------------------------|-------------------------------|--|
| 16:9 Screen | 480i/p | 576i/p | 1080i/p | 720p | PC |
| 4:3 | 1440 x 1080 center | | | | |
| 16:9 | 1920 x 1080 center | | | | |
| LBX (#1) | Catch 720x363 (Center) | Catch 720x436 (Center) | Catch 1920x817 (Center) | Catch 1920x545 (Center) | Catch 75.65% of height (Center) |
| | Scale to 1920x1440, then get the central 1920x1080 image to display | | | | |
| Auto235 (#1) (same button on remote of Native) | When source is 2.35:1 (with black bar at top/bottom), Doing LBX format. When source isn't 2.35:1 that is full 4x3 or 16x9 (There is no black bar at top/bottom), doing 16x9 format | | | | |
| Auto235_Subtitle | Catch 720x422 (bottom) | Catch 720x506 (bottom) | Catch 1920x948 (bottom) | Catch 1920x632 (bottom) | Catch 87.8% of height (bottom) |
| | When source is 2.35:1 (with black bar at top/bottom), Doing above catching rule and Scale to 1920x1440, then get the central 1920x1080 image to display. When source isn't 2.35:1 that is full size 4x3 or 16x9 (There is no black bar at top/bottom), doing 16x9 format | | | | |

User Controls

| When anamorphic lens is fixed | | | | | |
|---|---|------------------------------|-------------------------------|-------------------------------|--|
| 16:9 Screen | 480i/p | 576i/p | 1080i/p | 720p | PC |
| 4:3 | 1080 x 1080 center | | | | |
| 16:9 | 1440 x 1080 center | | | | |
| LBX (#1) | Catch 720x363 (Center) | Catch 720x436 (Center) | Catch 1920x817 (Center) | Catch 1920x545 (Center) | Catch 75.65% of height (Center) |
| | Scale to 1920x1440, then get the central 1920x1080 image to display | | | | |
| Auto235 (#1) (same button on remote of Native) | When source is 2.35:1 (with black bar at top/bottom), Doing LBX format. When source isn't 2.35:1 that is full 4x3 or 16x9 (There is no black bar at top/bottom), doing 16x9 format | | | | |
| Auto235_Subtitle | Catch 720x422 (bottom) | Catch 720x506 (bottom) | Catch 1920x948 (bottom) | Catch 1920x632 (bottom) | Catch 87.8% of height (bottom) |
| | When source is 2.35:1 (with black bar at top/bottom), Doing above catching rule and Scale to 1920x1440, then get the central 1920x1080 image to display. When source isn't 2.35:1 that is full size 4x3 or 16x9 (There is no black bar at top/bottom), doing 16x9 format | | | | |



- ❖ Each I/O has different setting of "Edge Mask".

Edge Mask

Edge mask the image to remove video encoding noise on the edge of video source.

Zoom

- ▶ Press the ◀ to reduce the size of an image.
- ▶ Press the ▶ to magnify an image on the projection screen.

Image Shift

Press ▶ into the next menu as below and then use ▲ or ▼ or ◀ or ▶ to select item.

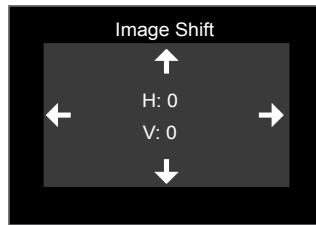

- ▶ H: Press the ◀ ▶ to shift the projected image position horizontally.
- ▶ V: Press the ▲ ▼ to shift the projected image position vertically.

V Keystone

Press the ◀ or ▶ to adjust image distortion vertically and make a squarer image.

DISPLAY | 3D

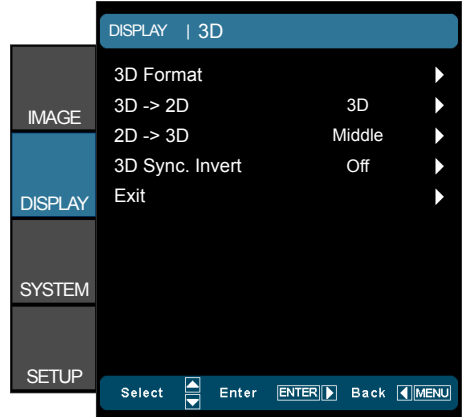

- ❖ “3D Sync. Invert” function wouldn’t save the setting. It will set to “Off” when powers on and changes source.
- ❖ 3D Format is only supported on 3D Timing on page 55.
- ❖ “3D Format” is only supported on non-HDMI 1.4a 3D timing.

3D -> 2D

- ▶ 3D: Display 3D signal.
- ▶ L (Left): Display the left frame of 3D content.
- ▶ R (Right): Display the right frame of 3D content.

2D -> 3D

- ▶ Select 3D depth of field (or strength) from Low, Middle or High.

3D Format

- ▶ Auto: Display the native format.
- ▶ SBS: Display 3D signal in “Side-by-Side” format.
- ▶ Top and Bottom: Display 3D signal in “Top and Bottom” format.
- ▶ Frame Sequential: Display 3D signal in “Frame Sequential” format.
- ▶ 2D -> 3D: 2D signal transform 3D signal.

3D Sync. Invert

- ▶ Press the “On” to invert left and right frame contents.
- ▶ Press the “Off” for default frame contents.

SYSTEM

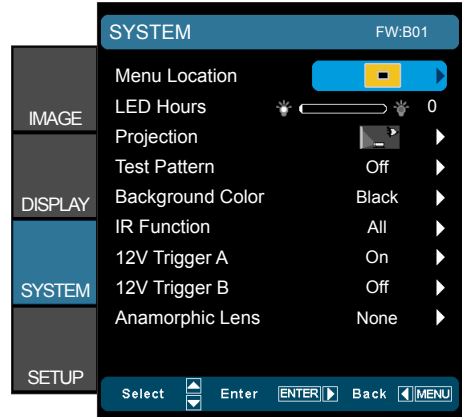

Menu Location

Choose the menu location on the display screen.

LED Hours

Display the LED time.

Projection



- ❖ Rear-Desktop and Rear-Ceiling are to be used with a translucent screen.

- ▶  Front-Projection

This is the default selection. The image is projected straight on the screen.

- ▶  Rear-Desktop

When selected, the image will appear reversed.

- ▶  Front-Ceiling

When selected, the image will turn upside down.

- ▶  Rear-Ceiling

When selected, the image will appear reversed in upside down position

Test Pattern

Display a test pattern. There are Grid, White pattern and Off.

Background Color

Use this feature to display a “Black”, “Blue”, or “Grey” screen when no signal is available.

IR Function

- ▶ All: Choose “All”, the projector can be operated by the remote control from front or top IR receiver.
- ▶ Front: Choose “Front”, the projector can be operated by the remote control from front IR receiver.

User Controls

- ▶ Top: Choose “Top”, the projector can be operated by the remote control from top IR receiver.

12V Trigger A

12V trigger A provides a standard trigger for motorized screens.

12V Trigger B (#1)

- ▶ Press the “Off” to disable the trigger.
- ▶ Press the “On” to enable the trigger and the programmable sub-menu. The sub-menu is accessed by selecting the “On” option then pressing the “Enter” button on the remote control. Checking an option in the sub-menu will activate the trigger when the corresponding display mode is selected. For the example, 4:3 has been selected – this means that Trigger B will be active when the projector display mode is set to 4:3. The trigger will be inactive for all the other display mode options.



- ❖ (#1) When the movable lens is selected, this item will be gray out and become “Auto235”.

▶ Auto235:

- ▶ Auto 3D: When “Auto 3D” is enabled, the projector will automatically detect when a 3D image is shown and will activate the trigger on this port.

User Controls

Anamorphic Lens

Select an anamorphic Lens from “None”, “Fixed”, or “Movable”.

| | (12V Trigger B) | | | |
|-------------------|-----------------|----|---------|---------|
| (Anamorphic Lens) | Off | On | Auto235 | Auto 3D |
| None | ✓ | ✓ | | ✓ |
| Fixed | | | ✓ | |
| Movable | | | ✓ | |

User Controls

SETUP

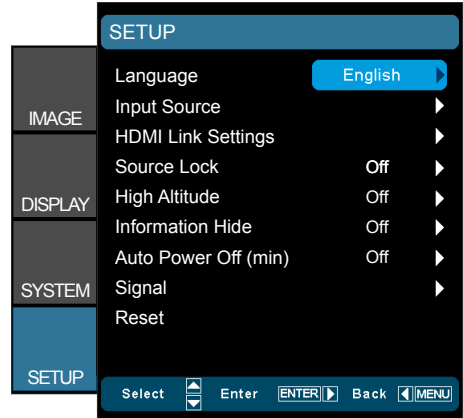

Language

Choose the multilingual OSD menu. Press ► into the sub menu and then use the ▲ or ▼ or ◀ or ▶ key to select your preferred language. Press “Enter” to finalize the selection.



Input Source

Use this option to enable / disable input sources. Press ► to enter the sub menu and select which sources you require. Press “Enter” to finalize the selection. The projector will only search for inputs that are enabled.

User Controls

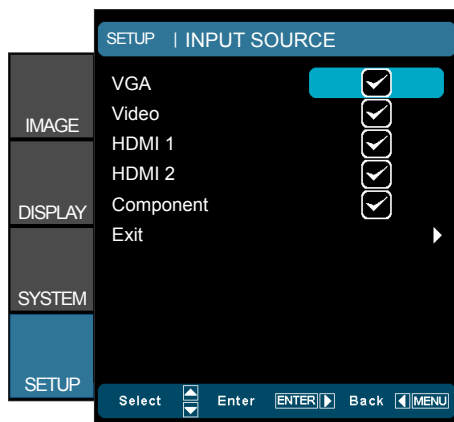

HDMI Link Settings

See pages 45-46 for more information.

Source Lock

- ▶ On: The projector will only search current input connection.
- ▶ Off: The projector will search for other signals if the current input signal is lost.

High Altitude

When “On” is selected, the fans will spin faster. This feature is useful in high altitude areas where the air is thin.

Information Hide

- ▶ On: Choose “On” to hide the info message.
- ▶ Off: Choose “Off” to show the “searching” message.

Auto Power Off (min)

Sets the countdown timer interval. The countdown timer will start, when there is no signal being sent to the projector. The projector will automatically power off when the countdown has finished (in minutes).

Reset

- ▶ Current: Choose “Yes” to return the display parameters on this menu to the factory default settings.
- ▶ All: Choose “Yes” to return the display parameters on all menus to the factory default settings.

SETUP | HDMI Link Settings

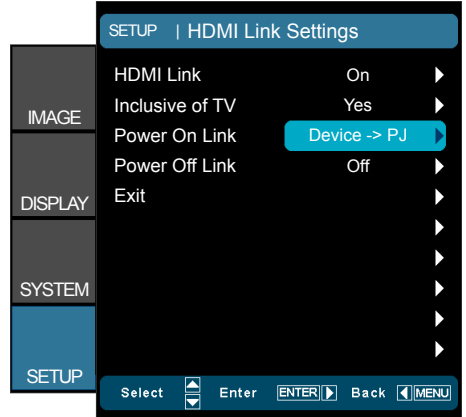

Using HDMI Link



- ❖ When HDMI Link is set to Off, the standby mode is <math>< 0.5W</math>.

- When you connect HDMI CEC-compatible devices to the projector with HDMI cables, you can control them on same Power On or Power Off status using the HDMI Link control feature on the projector's OSD.
- This lets one device or multiple devices in a group Power On or Power Off via HDMI Link Feature.
- In a typical configuration, your DVD player may be connected to the projector through an amplifier or home theater system.

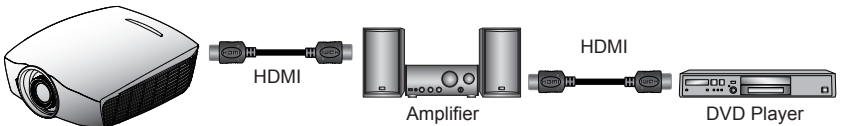

- ❖ Some HDMI Link functions may not operate, depending on the connected product's design and compliance with the HDMI CEC standard.

HDMI Link

Enable/Disable the HDMI Link function. The Inclusive TV, Power on Link, and Power off Link options will only available if the setting is set to On.

Inclusive of TV

If the setting is set to "Yes", both TV and projector will be automatically turned off at the same time. To prevent both devices to be turned off at the same time, set the setting to "No".

Power On Link

CEC power on command

- ▶ Mutual: Both projector and CEC device will be turned on simultaneously.

User Controls

- ▶ PJ -> Device: The CEC device will be turned on only after the projector is switched on.
- ▶ Device -> PJ: The projector will be switched on only after the CEC device is turned on.

Power Off Link

If the setting is set to “On”, both HDMI Link and projector will be automatically turned off at the same time. Set to “Off”, both HDMI Link and projector will be not automatically turned off at the same time.

SETUP | Signal (VGA)



- ❖ "Signal" is only supported in Analog VGA (RGB) signal.

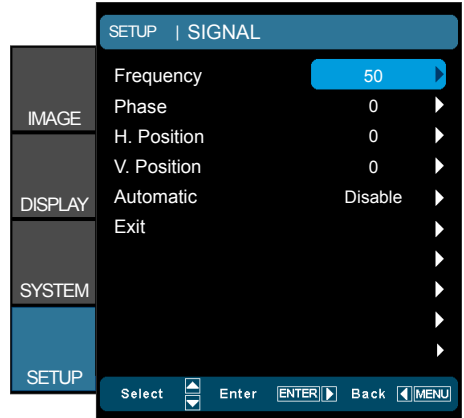

Frequency

Change the display data frequency to match the frequency of your computer's graphic card. Use this function only if the image appears to flicker vertically.

Phase

Synchronize the signal timing of the display with the graphic card. If the image appears to be unstable or flickers, use this function to correct it.

H. Position

- ▶ Press the ◀ to move the image left.
- ▶ Press the ▶ to move the image right.

V. Position

- ▶ Press the ◀ to move the image down.
- ▶ Press the ▶ to move the image up.

Automatic

Automatically configures the signal (the Frequency and Phase items are grayed out). If Automatic is disabled, the Frequency and Phase items will appear for user to manually tune and save the settings.

SETUP | Signal (Video)



- ❖ "Signal" is not supported when the source is HDMI.
- ❖ "IRE" is only supported on NTSC signal.

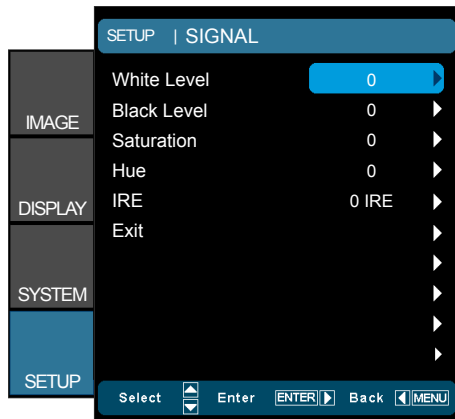

White Level

Allow user adjust White Level when inputting Video signals.

Black Level

Allow user adjust Black Level when inputting Video signals.

Saturation

Adjust a video image from black and white to fully saturated color.

- ▶ Press the ◀ to decrease the amount of color in the image.
- ▶ Press the ▶ to increase the amount of color in the image.

Hue

Adjust the color balance of red and green.

- ▶ Press the ◀ to increase the amount of green in the image.
- ▶ Press the ▶ to increase the amount of red in the image.

IRE

Adjust measurement of composite video signals.

Troubleshooting

If you experience a problem with your projector, please refer to the following information. If a problem persists, please contact your local reseller or service center.

Image Problems

No image appears on-screen

- ▶ Ensure all the cables and power connections are correctly and securely connected as described in the “Installation” section.
- ▶ Ensure the pins of connectors are not crooked or broken.
- ▶ Make sure you have removed the lens cap and the projector is switched on.

Image is out of focus

- ▶ Make sure the Lens cap is removed.
- ▶ Adjust the Focus Ring on the projector lens.
- ▶ Make sure the projection screen is between the required distance from the projector. (refer to pages 20-21)

The image is stretched when displaying 16:9 DVD title

- ▶ When you play anamorphic DVD or 16:9 DVD, the projector will show the best image in 16: 9 format on projector side.
- ▶ If you play the LBX format DVD title, please change the format as LBX in projector OSD.
- ▶ If you play 4:3 format DVD title, please change the format as 4:3 in projector OSD.
- ▶ If the image is still stretched, you will also need to adjust the aspect ratio by referring to the following:
- ▶ Please setup the display format as 16:9 (wide) aspect ratio type on your DVD player.

Image is too small or too large

- ▶ Adjust the zoom lever on the top of the projector.
- ▶ Move the projector closer to or further from the screen.
- ▶ Press “Menu” on the projector panel, go to “DISPLAY-->Format”. Try the different settings.

Image has slanted sides:

- ▶ If possible, reposition the projector so that it is centered on the screen and below the bottom of the screen.
- ▶ Use “DISPLAY-->V Keystone” from the OSD to make an adjustment.

Image is reversed

- ▶ Select “SYSTEM-->Projection” from the OSD and adjust the projection direction.

Blurry double image

- ▶ Press “3D Format” button and switch to “Auto” to avoid normal 2D image is blurry double image.

Two images, side-by-side format

- ▶ Press “3D Format” button and switch to “SBS” for input signal is HDMI 1.3 2D 1080i side-by-side.

Image does not display in 3D

- ▶ Check if the battery of 3D glasses is drained.
- ▶ Check if the 3D glasses is turned on.
- ▶ When the input signal is HDMI 1.3 2D (1080i side-by-side half), press “3D Format” button and switch to “SBS”.

Other Problems

- ?** **The projector stops responding to all controls**
- ▶ If possible, turn off the projector, then unplug the power cord and wait at least 20 seconds before reconnecting power.

Remote Control Problems

- ?** **If the remote control does not work**
- ▶ Check the operating angle of the remote control is within $\pm 25^\circ$ both horizontally and vertically of one of the IR receivers on the projector.
 - ▶ Make sure there are not any obstructions between the remote control and the projector. Move to within 6 m (20 ft) of the projector.
 - ▶ Make sure batteries are inserted correctly.
 - ▶ Replace batteries if they are exhausted.

LED Lighting Messages



- ❖ Power LED on: No signal; OSD menu appears and signal had been detected.
- ❖ Power LED off: Signal had been detected but OSD menu disappears.

| Message | Power LED (Red) | Power LED (Blue) | Temp LED (Red) |
|-------------------------------------|--------------------|---------------------|-------------------|
| Standby State (Input power cord) | Steady light * | Off | Off |
| Power on (Warming) | Off | Flashing | Off |
| Power on and LED lighting | Off | Steady light | Off |
| Power off (Cooling) | Off | Flashing | Off |
| Error (LED fail) | Flashing | Off | Off |
| Error (Fan fail) | Flashing | Off | Flashing |
| Error (Over Temp.) | Flashing | Off | Steady light |

* ON/STANDBY LED be ON when OSD appears, be OFF when OSD disappears.

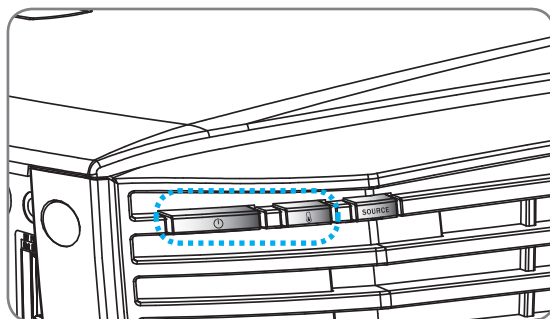

On Screen Messages

❖ Power off:

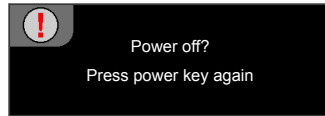

❖ LED warning:

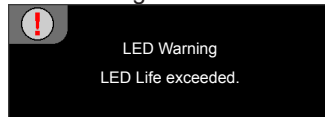

❖ Temperature warning:

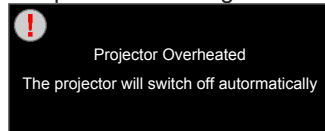

❖ Fan failed:

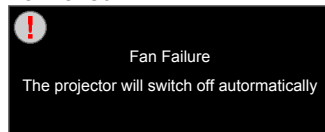

❖ Out of display range:

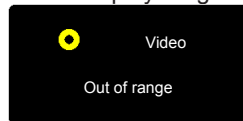

Compatibility Modes

❖ Computer/Video/HDMI/Mac Compatibility

| Signal | Resolution | Refresh Rate (Hz) | Video | Analog | HDMI | Mac |
|--------------|-------------|---------------------|---------------------|--------|------|-------------------|
| NTSC | 720 x 480 | 60 | O | - | - | - |
| PAL/SECAM | 720 x 576 | 50 | O | - | - | - |
| VGA | 640 x 480 | 60 | - | O | O | O |
| | 640 x 480 | 67 | - | O | - | - |
| | 640 x 480 | 72.8 | - | O | - | O |
| | 640 x 480 | 85 | - | O | - | O |
| SVGA | 800 x 600 | 56.3 | - | O | - | - |
| | 800 x 600 | 60.3 | - | O | O | O |
| | 800 x 600 | 72.2 | - | O | O | O |
| | 800 x 600 | 85.1 | - | O | O | O |
| XGA | 800 x 600 | 120 ^{(*)2} | - | O | O | - |
| | 1024 x 768 | 60 | - | O | O | O |
| | 1024 x 768 | 70.1 | - | O | O | O |
| | 1024 x 768 | 75 | - | O | O | O |
| | 1024 x 768 | 85 | - | O | O | O |
| HDTV (720p) | 1024 x 768 | 120 ^{(*)2} | - | O | O | - |
| | 1280 x 720 | 50 | O | O | O | - |
| | 1280 x 720 | 60 | O | O | O | O |
| | 1280 x 720 | 120 ^{(*)2} | - | O | O | - |
| | WXGA | 1280 x 720 | 120 ^{(*)2} | - | O | O |
| 1280 x 768 | | 60 | - | O | O | O ^{(*)3} |
| 1280 x 768 | | 75 | - | O | O | O |
| 1280 x 768 | | 85 | - | O | O | O ^{(*)3} |
| SXGA | 1280 x 800 | 60 | - | O | O | O |
| | 1280 x 1024 | 60 | - | O | O | O |
| | 1280 x 1024 | 75 | - | O | O | O |
| SXGA+ | 1280 x 1024 | 85 | - | O | O | - |
| | 1400 x 1050 | 60 | - | O | O | - |
| UXGA | 1600 x 1200 | 60 | - | O | O | - |
| HDTV (1080p) | 1920 x 1080 | 60 | - | O | O | - |
| | 1920 x 1080 | 24 | O | O | O | - |
| | 1920 x 1080 | 30 | - | - | O | - |
| | 1920 x 1080 | 50 | O | O | O | - |
| HDTV (1080i) | 1920 x 1080 | 60 | O | O | O | O |
| | 1920 x 1080 | 50 | O | - | O | - |
| WUXGA | 1920 x 1080 | 60 | O | - | O | - |
| | 1920 x 1200 | 60 ^{(*)1} | - | O | O | O |



- ❖ (*1) 1920 x1200 @60Hz only support RB (reduced blanking).
- ❖ (*2) 3D timing for True 3D projector.
- ❖ (*3) is not supported HDMI input signal for Mac.
- ❖ 120Hz input signals may be dependent on graphics cards support.

Appendices

| Signal | Resolution | Refresh Rate (Hz) | Video | Analog | HDMI | Mac |
|-------------|------------|-------------------|-------|--------|------|-----|
| SDTV (576i) | 720 x 576 | 50 | O | - | O | - |
| SDTV (576p) | 720 x 576 | 50 | O | - | O | - |
| SDTV (480i) | 720 x 480 | 60 | O | - | O | - |
| SDTV (480p) | 720 x 480 | 60 | O | - | O | - |

❖ 3D Input Video Compatibility

| Input Resolution | HDMI 1.4a 3D Input | Input Timing | | |
|------------------|----------------------|---------------------|---------------------|---------------------------------------|
| | | 1280 x 720p @ 50Hz | Top-and-Bottom | |
| | 1280 x 720p @ 60Hz | Top-and-Bottom | | |
| | 1280 x 720p @ 50Hz | Frame packing | | |
| | 1280 x 720p @ 60Hz | Frame packing | | |
| | 1920 x 1080i @ 50 Hz | Side-by-Side (Half) | | |
| | 1920 x 1080i @ 60 Hz | Side-by-Side (Half) | | |
| | 1920 x 1080p @ 24 Hz | Top-and-Bottom | | |
| | 1920 x 1080p @ 24 Hz | Frame packing | | |
| | HDMI 1.3 3D Content | 1920 x 1080p @ 60Hz | Side-by-Side (Half) | While 3D Format is "SBS" |
| | | 1920 x 1080i @ 50Hz | | |
| | | 1920 x 1080i @ 60Hz | | |
| | | 1280 x 720p @ 50Hz | | |
| | | 1280 x 720p @ 60Hz | Top-and-Bottom | While 3D Format is "Top and Bottom" |
| | | 1920 x 1080p @ 60Hz | | |
| | | 1920 x 1080i @ 50Hz | | |
| | | 1920 x 1080i @ 60Hz | | |
| | | 1280 x 720p @ 50Hz | HQFS | While 3D Format is "Frame Sequential" |
| | | 1280 x 720p @ 60Hz | | |
| | 480i | | | |

RS232 Commands and Protocol Function List

RS232 Pin Assignments

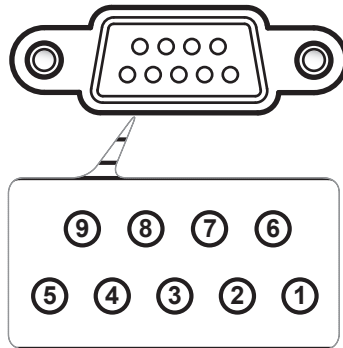

| Pin no. | Spec. (from projector side) |
|---------|--------------------------------|
| 1 | N/A |
| 2 | RXD |
| 3 | TXD |
| 4 | N/A |
| 5 | GND |
| 6 | N/A |
| 7 | N/A |
| 8 | N/A |
| 9 | N/A |

Appendices

RS232 Protocol Function List

Baud Rate : 9600
 Data Bits : 8
 Parity : None
 Stop Bits : 1
 Flow Control : None
 UART16550 FIFO: Disable

Projector Return (Pass): P
 Projector Return (Fail): F
 XX=00-99, projector's ID,
 XX=00 is for all projectors
 There is a <CR> after all commands.
 0D is the HEX code for <CR> in ASCII code.

| - | X | X | X | X | X | X | space | n | CR | |
|------------------------|-------------------|--|--|----|----------|--------------------------------|----------|----------|-----------------|---|
| | Projector ID | | Command ID | | | | | variable | carriage return | |
| Power/ Re-sync | | Function | Cmd/Off | | | ASCII | | Pass | Fail | |
| | | | | | | Hex/Dec & 2 | | | | |
| Direct Source Commands | | MEM1 | | | | m1 | | P | F | |
| | | VGA Component | | | | m2 | | P | F | |
| | | Component B/C/A | | | | m3 | | P | F | |
| | | MEM2 | | | | m4 | | | | |
| Display Mode | | Cinema | | | | m1 | -XX00.n | P | F | |
| | | Film | | | | m1 | | | | |
| | | Bright | | | | m2 | | | | |
| | | Photo | | | | m3 | | | | |
| | | Reference | | | | m4 | | | | |
| | | User | | | | m5 | | | | |
| | | ISP Day | | | | m7 | | | | |
| | | ISP Night | | | | m8 | | | | |
| | | 3D | | | | m9 | | | | |
| | | Brightness | | | | m0 | -XX01.n | P | F | |
| | Contrast | | | | m1 | -XX02.n | P | F | | |
| | Sharpness | | | | m2 | -XX03.n | P | F | | |
| | Tint | | | | m3 | -XX04.n | P | F | | |
| | Color | | | | m4 | -XX05.n | P | F | | |
| Color Settings | RGB Gain/Bias | Red Gain | | | | m0 | -XX06.n | | | |
| | | Green Gain | | | | m1 | -XX07.n | | | |
| | | Blue Gain | | | | m2 | -XX08.n | | | |
| | | Red Bias | | | | m3 | -XX09.n | | | |
| | | Green Bias | | | | m4 | -XX10.n | | | |
| | | Blue Bias | | | | m5 | -XX11.n | | | |
| | Color Temperature | Reset | | | | m1 | -XX12.n | | | |
| | | D65 | | | | m2 | -XX13.n | | | |
| | | D69 | | | | m3 | -XX14.n | | | |
| | | D75 | | | | m4 | -XX15.n | | | |
| | | D83 | | | | m5 | -XX16.n | | | |
| | | D93 | | | | m6 | -XX17.n | | | |
| | Color Gamut | Native | | | | m1 | -XX18.n | | | |
| | | Native | | | | m2 | -XX19.n | | | |
| | | Adobe | | | | m3 | -XX20.n | | | |
| | | D1 P. Gamma | | | | m4 | -XX21.n | | | |
| | | HDTV | | | | m5 | -XX22.n | | | |
| | | SMPTE-C | | | | m6 | -XX23.n | | | |
| | CMS | Red | | | | m1 | -XX24.n | | | |
| | | Green | | | | m2 | -XX25.n | | | |
| Blue | | | | | m3 | -XX26.n | | | | |
| Cyan | | | | | m4 | -XX27.n | | | | |
| Yellow | | | | | m5 | -XX28.n | | | | |
| Magenta | | | | | m6 | -XX29.n | | | | |
| x offset | | -50 ~ 50 | | | | m7 | -XX30.n | | | |
| y offset | | -50 ~ 50 | | | | m8 | -XX31.n | | | |
| Brightness | | -50 ~ 50 | | | | m9 | -XX32.n | | | |
| Reset | | | | | m1 | -XX33.n | | | | |
| Advanced | Gamma | Film | | | | m1 | -XX34.n | P | F | |
| | | Curve Type | Film/Video/Graphics/1/8 1/1.8/2.0/2.1/2.2/2.4/2.5/2.6 | | | m-5 ~ +6 | -XX182.n | | | |
| | | Offset | | | | m-5 ~ +5 | -XX183.n | | | |
| | Video | Reset | | | | m1 | -XX35.n | | | |
| | | Curve Type | Film/Video/Graphics/1/8 1/1.8/2.0/2.1/2.2/2.4/2.5/2.6 | | | m-5 ~ +6 | -XX184.n | | | |
| | | Offset | | | | m-5 ~ +5 | -XX185.n | | | |
| | Graphics | Reset | | | | m1 | -XX36.n | | | |
| | | Curve Type | Film/Video/Graphics/1/8 1/1.8/2.0/2.1/2.2/2.4/2.5/2.6 | | | m-5 ~ +6 | -XX186.n | | | |
| | | Offset | | | | m-5 ~ +5 | -XX187.n | | | |
| | Color Space | Reset | | | | m1 | -XX37.n | | | |
| | | Standard | | | | m1 | -XX38.n | | | |
| | | Curve Type | Film/Video/Graphics/1/8 1/1.8/2.0/2.1/2.2/2.4/2.5/2.6 | | | m-5 ~ +6 | -XX188.n | | | |
| Offset | | | | | m-5 ~ +5 | -XX189.n | | | | |
| Reset | | | | | m1 | -XX39.n | | | | |
| Auto | | | | | m1 | -XX40.n | P | F | | |
| RGB (0-255) | | * RGB (0-255) supports when HDMI is detected | | | m2 | -XX41.n | P | F | | |
| RGB (16 ~ 235) | | * RGB (16 ~ 235) supports when HDMI is detected | | | m3 | -XX42.n | P | F | | |
| Reset | | | | | m1 | -XX43.n | | | | |
| Noise Reduction | | YUV | | | | m1 | -XX44.n | | | |
| | | PureMotion | OFF | | | | m0 | -XX180.n | P | F |
| | | | LOW | | | | m1 | -XX181.n | | |
| | HIGH | | | | | m2 | -XX182.n | | | |
| | PureEngine | UltraDetail | | | | m1 | -XX183.n | | | |
| | | ON | | | | m2 | -XX184.n | | | |
| | | HEF | | | | m3 | -XX185.n | | | |
| | | PureColor | | | | m4 | -XX186.n | | | |
| | | 1 | | | | m5 | -XX187.n | | | |
| | | 2 | | | | m6 | -XX188.n | | | |
| | | 3 | | | | m7 | -XX189.n | | | |
| | | 4 | | | | m8 | -XX190.n | | | |
| PureFrame Demo | | | | m9 | -XX191.n | | | | | |
| LED Brightness | Power | 100%/95%/90%/85%/80%/75%/70%/65%/60%/50% | | | | m0(m1/m2/m3/m4/m5/m6/m7/m8/m9) | -XX026.n | P | F | |
| | DynamicBack 1 | | | | m2 | -XX191.n | P | F | | |
| | DynamicBack 2 | | | | m3 | -XX192.n | P | F | | |
| | DynamicBack 3 | | | | m4 | -XX193.n | P | F | | |
| | 0.5 | | | | m1 | -XX060.n | P | F | | |
| | 1.0 | | | | m2 | -XX061.n | P | F | | |
| Format | LBX | Don't support when Anamorphic lens is fixed | | | m5 | -XX062.n | | | | |
| | Native | Don't support when Anamorphic lens is motorized or fixed | | | m6 | -XX063.n | | | | |
| | Auto3:2 | | | | m7 | -XX064.n | | | | |
| | Auto2:3 | Supporting! When Anamorphic lens is fixed or motor | | | m8 | -XX065.n | | | | |
| | SuperWide | Don't support when Anamorphic lens is motorized or fixed | | | m9 | -XX066.n | | | | |
| Edge masking | SuperWide | | | | m1 | -XX067.n | | | | |
| | Reset | | | | m0 | -XX068.n | P | F | | |

Appendices

| | X | X | X | X | X | n | CR |
|--|--------------------------|-----------------------------|----------------------|------------------------------------|---------------|------------------|-----------------|
| | Projector ID | | Command ID | | space | variable | carriage return |
| DISPLAY | Zoom | | | | m=0-10 | -XX62 n | F |
| | H Image Shr | | | | m= -100 + 100 | -XX63 n | F |
| | V Image Shr | | | | m= -100 + 100 | -XX64 n | F |
| | V Keystone | | | | m= -30 + 30 | -XX66 n | F |
| | | 3D → 2D | | 2D → 2D; 3D → 3D / 3D → L / 3D → R | m=1m=2m=3 | -XX400 n | F |
| | | Auto | | Decoding HDMI1.3 | a=0 | -XX405 n | F |
| | | SBS | | 3D timing | m=1 | -XX406 n | F |
| | | Top and Bottom | | Low | m=2 | -XX407 n | F |
| | | Frame Sequential | | Mid | m=3 | -XX408 n | F |
| | | | | High | m=4 | -XX409 n | F |
| SYSTEM | | 3D Sync. Invert | On/Off | | m=0m=1 | -XX231 n | |
| | Menu Location | Top Left | | | m=1 | -XX72 n | P |
| | | Top Right | | | m=2 | | |
| | | Centre | | | m=3 | | |
| | | Bottom Left | | | m=4 | | |
| | | Bottom Right | | | m=5 | | |
| | LED Hours | | | | m=1 | -XX108 n | Ok |
| | Projection | Front-Ceiling | | | m=1 | -XX108 n | Ok |
| | | Rear-Desktop | | | m=2 | -XX109 n | F |
| | | Front-Ceiling | | | m=3 | | |
| Test Pattern | Rear-Ceiling | None / Grid / White Pattern | | m=4 | -XX105 n | | |
| Background Color | Blue | | | m=0m=1m=2 | -XX104 n | P | |
| | Black | | | m=1 | -XX104 n | F | |
| | Gray | | | m=6 | | | |
| IR Function | | All/None/Top | | m=0 m=1 m=2 | -XX111 n | P | |
| 12V Trigger A | | Off/On | | m=0m=1 | -XX102 n | F | |
| 12V Trigger B | | Off/On/Auto/2.5/Auto 3D | | m=0m=1m=2m=3 | -XX103 n | F | |
| | | 4.3 | 4.3 check | | -XX205 1 | | |
| | | 16:9 | 16:9 check | | -XX205 2 | | |
| | | 16:9 | 16:9 unchecked | | -XX205 3 | | |
| | | Letter Box | letter box check | | -XX205 4 | | |
| | | | letter box unchecked | | -XX205 5 | | |
| | | Native | native check | | -XX205 6 | | |
| | | | native unchecked | | -XX205 7 | | |
| | | Exit | | | | | |
| SETUP | Language | English | | | m=1 | -XX70 n | P |
| | | German | | | m=2 | | |
| | | French | | | m=3 | | |
| | | Italian | | | m=4 | | |
| | | Spanish | | | m=5 | | |
| | | Portuguese | | | m=6 | | |
| | | Polish | | | m=7 | | |
| | | Dutch | | | m=8 | | |
| | | Swedish | | | m=9 | | |
| | | Norwegian/Danish | | | m=10 | | |
| | | Finnish | | | m=11 | | |
| | | Greek | | | m=12 | | |
| | | Traditional Chinese | | | m=13 | | |
| | | Simplified Chinese | | | m=14 | | |
| | | Japanese | | | m=15 | | |
| | | Korean | | | m=16 | | |
| | | Russian | | | m=17 | | |
| | | Hungarian | | | m=18 | | |
| | | Czech | | | m=19 | | |
| | | Arabic | | | m=20 | | |
| | | Thai | | | m=21 | | |
| | | Turkish | | | m=22 | | |
| | | HDMI 1 | | | m=1 | -XX39 n | P |
| | Input Source Filters | HDMI 2 | | | m=7 | | |
| | | VGA | | | m=5 | | |
| | | 3 x RCA Component | | | m=8 | | |
| | | Video | On/Off | | m=10 | | |
| | Source Lock | | On/Off | | m=1m=0 & 2 | -XX100 n | P |
| | High Altitude | | On/Off | | m=1m=0 & 2 | -XX101 n | P |
| | Information Hide | | On/Off | | m=1m=0 & 2 | -XX102 n | P |
| Auto Power Off (min) | | On/Off | | m=0-180 | -XX106 n | P | |
| | Automatic | Enable/Disable | | m=1m=0 | -XX31 n | | |
| | Frequency/Tracking | | | m=0-100 | -XX73 n | P | |
| | Phase | | | m= -50 + 50 | -XX74 n | P | |
| | H. Position | | | m= -50 + 50 | -XX75 n | P | |
| | V. Position | | | m= -50 + 50 | -XX76 n | P | |
| | White level | | | m= -50 + 50 | -XX200 n | P | |
| | Black level | | | m= -50 + 50 | -XX201 n | P | |
| | Saturation | | | m= -50 + 50 | -XX202 n | P | |
| | Hum | | | m= -50 + 50 | -XX203 n | P | |
| | IRE | 0 IRE / 7.5 IRE | | m=1m=0 | -XX204 n | | |
| | | Yes | | m=1 | | | |
| | | No | | m=2 | -XX112 n | P | |
| Information from Projector Automatically when: | | | | | | | |
| | Standby Mode | | | a=0 | INFOa | | |
| | Warming up | | | a=1 | INFOa | | |
| | Cooling Down | | | a=2 | INFOa | | |
| | Out of Range | | | a=3 | INFOa | | |
| | LED Fail | | | a=4 | INFOa | | |
| | Thermal Switch Error | | | a=5 | | | |
| | Fan Lock | | | a=6 | | | |
| | Over Temperature | | | a=7 | | | |
| | Lamp Hours Running Out | | | a=8 | | | |
| READ Return Information from projector | | | | | | | |
| | Information | | | m=1 | -XX150 n | Okabbbbbbccdddee | |
| | a = Power State | Off/On | | a=0/1 | | | |
| | b = LED Hour | | | bbbbb | | | |
| | c = Most Source Commands | None | | c=0 | | | |
| | | VGA | | c=02 | | | |
| | | Video | | c=05 | | | |
| | | HDMI1 | | c=07 | | | |
| | | HDMI2 | | c=08 | | | |
| | d = Firmware Version | | | ddddd | | | |
| | e = Display mode | None | | eee=0 | | | |
| | | Cinema | | eee=1 | | | |
| | | Right | | eee=2 | | | |
| | | Film | | eee=11 | | | |
| | | Photo | | eee=3 | | | |
| | Reference | Right | | eee=4 | | | |
| | | User | | eee=5 | | | |
| | | ISF Day | | eee=7 | | | |
| | | ISF Night | | eee=8 | | | |
| | | 3D | | eee=9 | | | |
| | Model Name | Depends | | aaa5/12 | -XX151 n | Ok | |
| RS232 Version No. | | | | m=1 | -XX152 n | Ok | |

Appendices

| - | X | X | X | X | X | n | CR |
|----------------|-----------------------|---|------------|-------|----------|----------|--|
| | Projector ID | | Command ID | space | variable | | carriage return |
| | | Depends | | | a=??? | | |
| | Input Source Commands | None/VGA/Video/HDMI1/ HDMI2/Component | | | n=1 | -XX121 n | Ok a=02/5/7/8/11 |
| | Software Version | | | | n=1 | -XX122 n | Okddd |
| | Display Mode | None/Cinema/Bright/Photo/ Reference/User/ISF Day/ ISF Night/3D/Film | | | n=1 | | Ok a=012/3/4/5/7/8/9/11 |
| | Power State | On/Off | | | n=1 | -XX123 n | Ok |
| | Brightness | | | | n=1 | -XX124 n | Ok a=1/0 |
| | Contrast | | | | n=1 | -XX125 n | Ok |
| | Aspect Ratio | 4:3/16:9/LB/X/None/Auto235/ Auto235_Subtitle | | | n=1 | | Ok a=1/2/5/6/8/9/11 for 4:3/16:9/LB/X/ Native/Auto235/ Auto235_Subtitle |
| | Color Temperature | D50/D65/D70/D75/D80/D90/ Native | | | n=1 | -XX126 n | Ok a=1/2/3/4/5/6/7 |
| | Projection Mode | Front-Desktop Rear-Desktop Front-Ceiling Rear-Ceiling | | | n=1 | -XX129 n | Ok a=01/2/3 for Front- Desktop/Rear-Desktop /Front-Ceiling/Rear- Ceiling |
| Remote Control | | | | | | | |
| | Up | | | | n=10 | -XX140 n | |
| | Left | | | | n=11 | | |
| | Enter | | | | n=12 | | |
| | Right | | | | n=13 | | |
| | Down | | | | n=14 | | |
| | Menu | | | | n=20 | | |
| | Re-sync | | | | n=41 | | |

Ceiling Mount Installation

1. To prevent damage to your projector, please use the Optoma ceiling mount.
2. If you wish to use a third party ceiling mount kit, please ensure the screws used to attach a mount to the projector meet the following specifications:
 - ▶ Screw type: M6
 - ▶ Maximum screw length: 12mm
 - ▶ Minimum screw length: 10mm



❖ Please note that damage resulting from incorrect installation will void the warranty.



Warning:

1. If you buy a ceiling mount from another company, please be sure to use the correct screw size. Screw size will vary depending on the thickness of the mounting plate.
2. Be sure to keep at least 10 cm gap between the ceiling and the bottom of the projector.
3. Avoid installing the projector near a heat source.

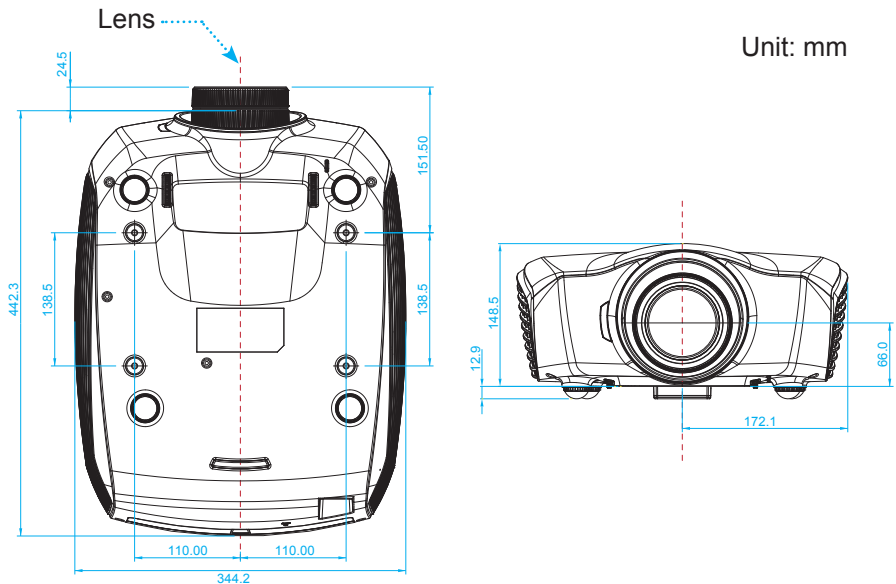



Optoma Global Offices

For service or support please contact your local office.



USA

3178 Laurelview Ct.
Fremont, CA 94538, USA
www.optomausa.com

 888-289-6786
 510-897-8601
 services@optoma.com



Canada

3178 Laurelview Ct.
Fremont, CA 94538, USA
www.optomausa.com

 888-289-6786
 510-897-8601
 services@optoma.com



Latin America

3178 Laurelview Ct.
Fremont, CA 94538, USA
www.optomausa.com

 888-289-6786
 510-897-8601
 services@optoma.com



Europe

42 Caxton Way, The Watford Business Park Watford, Hertfordshire, WD18 8QZ, UK
www.optoma.eu
Service Tel: +44 (0)1923 691865

 +44 (0) 1923 691 800
 +44 (0) 1923 691 888
 service@tsc-europe.com



Benelux BV

Randstad 22-123
1316 BW Almere
The Netherlands
www.optoma.nl

 +31 (0) 36 820 0253
 +31 (0) 36 548 9052



France

Bâtiment E
81-83 avenue Edouard Vaillant
92100 Boulogne Billancourt, France

 +33 1 41 46 12 20
 +33 1 41 46 94 35
 savoptoma@optoma.fr

Spain



C/ José Hierro, 36 Of. 1C 28522
Rivas Vaciamadrid,
Spain

 +34 91 499 06 06
 +34 91 670 08 32

Appendices



Deutschland

Wiesenstrasse 21 W
D40549 Düsseldorf,
Germany

 +49 (0) 211 506 6670
 +49 (0) 211 506 66799
 info@optoma.de

Scandinavia



Lerpeveien 25
3040 Drammen
Norway

 +47 32 98 89 90
 +47 32 98 89 99
 info@optoma.no

PO.BOX 9515
3038 Drammen
Norway

Korea

WOOMI TECH.CO.,LTD.
4F, Minu Bldg. 33-14, Kangnam-Ku,
seoul,135-815, KOREA

 +82+2+34430004
 +82+2+34430005



Japan

東京都足立区綾瀬3-25-18
株式会社オーエスエム
サポートセンター: 0120-46-5040

 info@osscreen.com
www.os-worldwide.com



Taiwan

12F., No.215, Sec. 3, Beixin Rd.,
Xindian Dist., New Taipei City 231,
Taiwan, R.O.C.
www.optoma.com.tw

 +886-2-8911-8600
 +886-2-8911-6550
 services@optoma.com.tw
asia.optoma.com



Hong Kong

Unit A, 27/F Dragon Centre,
79 Wing Hong Street,
Cheung Sha Wan,
Kowloon, Hong Kong

 +852-2396-8968
 +852-2370-1222
www.optoma.com.hk

China

5F, No. 1205, Kaixuan Rd.,
Changning District
Shanghai, 200052, China

 +86-21-62947376
 +86-21-62947375
www.optoma.com.cn

Regulation & Safety Notices

This appendix lists the general notices of your projector.

FCC Notice

This device has been tested and found to comply with the limits for a Class B digital device pursuant to Part 15 of the FCC rules. These limits are designed to provide reasonable protection against harmful interference in a residential installation. This device generates, uses and can radiate radio frequency energy and, if not installed and used in accordance with the instructions, may cause harmful interference to radio communications.

However, there is no guarantee that interference will not occur in a particular installation. If this device does cause harmful interference to radio or television reception, which can be determined by turning the device off and on, the user is encouraged to try to correct the interference by one or more of the following measures:

- ❖ Reorient or relocate the receiving antenna.
- ❖ Increase the separation between the device and receiver.
- ❖ Connect the device into an outlet on a circuit different from that to which the receiver is connected.
- ❖ Consult the dealer or an experienced radio/television technician for help.

Notice: Shielded cables

All connections to other computing devices must be made using shielded cables to maintain compliance with FCC regulations.

Caution

Changes or modifications not expressly approved by the manufacturer could void the user's authority, which is granted by the Federal Communications Commission, to operate this projector.

Operation Conditions

This device complies with Part 15 of the FCC Rules. Operation is subject to the following two conditions:

1. This device may not cause harmful interference and
2. This device must accept any interference received, including interference that may cause undesired operation.

Notice: Canadian users

This Class B digital apparatus complies with Canadian ICES-003.

Remarque à l'intention des utilisateurs canadiens

Cet appareil numérique de la classe B est conforme à la norme NMB-003 du Canada.

Declaration of Conformity for EU countries

- EMC Directive 2004/108/EC (including amendments)
- Low Voltage Directive 2006/95/EC
- R & TTE Directive 1999/5/EC (if product has RF function)



Disposal instructions

Do not throw this electronic device into the trash when discarding. To minimize pollution and ensure utmost protection of the global environment, please recycle it.

Trademarks

- DLP is trademarks of Texas Instruments.
- IBM is a trademark or registered trademark of International Business Machines Corporation.
- Macintosh, Mac OS X, iMac, and PowerBook are trademarks of Apple Inc., registered in the U.S. and other countries.
- Microsoft, Windows, Windows Vista, Internet Explorer and PowerPoint are either a registered trademark or trademark of Microsoft Corporation in the United States and/or other countries.
- HDMI, the HDMI Logo and High-Definition Multimedia Interface are trademarks or registered trademarks of HDMI Licensing LLC.
- Other product and company names mentioned in this user's manual may be the trademarks or registered trademarks of their respective holders.