

DLP® Projector

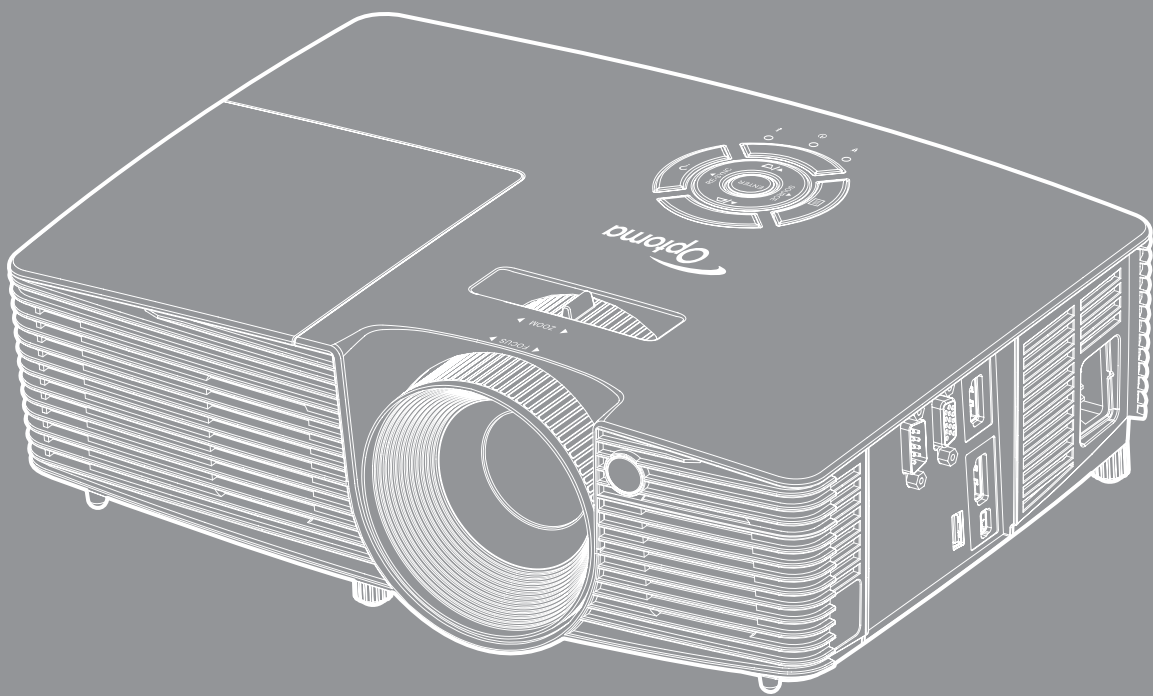

TABLE OF CONTENTS

SAFETY	4
<i>Important Safety Instruction.....</i>	<i>4</i>
<i>3D Safety Information.....</i>	<i>5</i>
<i>Copyright.....</i>	<i>6</i>
<i>Disclaimer.....</i>	<i>6</i>
<i>Trademark Recognition</i>	<i>6</i>
<i>FCC</i>	<i>7</i>
<i>Declaration of Conformity for EU countries</i>	<i>7</i>
<i>WEEE.....</i>	<i>7</i>
INTRODUCTION.....	8
<i>Package Overview.....</i>	<i>8</i>
<i>Standard accessories.....</i>	<i>8</i>
<i>Optional accessories.....</i>	<i>8</i>
<i>Product Overview</i>	<i>9</i>
<i>Connections.....</i>	<i>10</i>
<i>Keypad</i>	<i>11</i>
<i>Remote control.....</i>	<i>12</i>
SETUP AND INSTALLATION.....	13
<i>Installing the projector</i>	<i>13</i>
<i>Connecting sources to the projector.....</i>	<i>14</i>
<i>Adjusting the projector image.....</i>	<i>15</i>
<i>Remote setup</i>	<i>16</i>
USING THE PROJECTOR.....	18
<i>Powering on / off the projector.....</i>	<i>18</i>
<i>Selecting an input source</i>	<i>20</i>
<i>Menu navigation and features</i>	<i>21</i>
<i>OSD Menu tree.....</i>	<i>22</i>
<i>Image menu.....</i>	<i>28</i>
<i>Image advanced menu.....</i>	<i>31</i>
<i>Image advanced signal menu.....</i>	<i>34</i>
<i>Display menu.....</i>	<i>36</i>
<i>Display 3D menu</i>	<i>38</i>
<i>Setup menu</i>	<i>40</i>
<i>Setup audio settings menu.....</i>	<i>42</i>
<i>Setup security menu.....</i>	<i>43</i>
<i>Setup advanced menu.....</i>	<i>45</i>
<i>Options menu</i>	<i>46</i>

<i>Options HDMI link settings menu</i>	51
<i>Options remote settings menu</i>	53
<i>Options optional filter settings menu</i>	54
<i>Options advanced menu</i>	55
<i>3D Setup</i>	57

MAINTENANCE 58

<i>Replacing the lamp</i>	58
<i>Installing and cleaning the dust filter</i>	61

ADDITIONAL INFORMATION 62

<i>Compatible resolutions</i>	62
<i>Image size and projection distance</i>	64
<i>Projector dimensions and ceiling mount installation</i>	65
<i>RS232 protocol function list</i>	66
<i>IR remote codes</i>	71
<i>Using the Help button</i>	73
<i>Troubleshooting</i>	77
<i>Warning indicators</i>	79
<i>Specifications</i>	82
<i>Optoma global offices</i>	83

SAFETY

	The lightning flash with arrow head within an equilateral triangle is intended to alert the user to the presence of uninsulated "dangerous voltage" within the product's enclosure that may be of sufficient magnitude to constitute a risk of electric shock to persons.
	The exclamation point within an equilateral triangle is intended to alert the user to the presence of important operating and maintenance (servicing) instructions in the literature accompanying the appliance.

Please follow all warnings, precautions and maintenance as recommended in this user's guide.

Important Safety Instruction

- Do not block any ventilation openings. To ensure reliable operation of the projector and to protect from over heating, it is recommended to install the projector in a location that does not block ventilation. As an example, do not place the projector on a crowded coffee table, sofa, bed, etc. Do not put the projector in an enclosure such as a book case or a cabinet that restricts air flow.
- To reduce the risk of fire and/or electric shock, do not expose the projector to rain or moisture. Do not install near heat sources such as radiators, heaters, stoves or any other apparatus such as amplifiers that emits heat.
- Do not let objects or liquids enter the projector. They may touch dangerous voltage points and short out parts that could result in fire or electric shock.
- Do not use under the following conditions:
 - In extremely hot, cold or humid environments.
 - (i) Ensure that the ambient room temperature is within 5°C ~ 40°C
 - (ii) Relative humidity is 10% ~ 85%
 - In areas susceptible to excessive dust and dirt.
 - Near any appliance generating a strong magnetic field.
 - In direct sunlight.
- Do not use the projector in places where flammable gases or explosives gases may be present in the atmosphere. The lamp inside the projector becomes very hot during operation and the gases may ignite and result in a fire.
- Do not use the unit if it has been physically damaged or abused. Physical damage/abuse would be (but not limited to):
 - Unit has been dropped.
 - Power supply cord or plug has been damaged.
 - Liquid has been spilled on to the projector.
 - Projector has been exposed to rain or moisture.
 - Something has fallen in the projector or something is loose inside.
- Do not place the projector on an unstable surface. The projector may fall over resulting in injury or the projector may become damaged.
- Do not block the light coming out of the projector lens when in operation. The light will heat the object and may melt, cause burns or start a fire.
- Please do not open or disassemble the projector as this may cause electric shock.
- Do not attempt to service the unit yourself. Opening or removing covers may expose you to dangerous voltages or other hazards. Please call Optoma before you send the unit for repair.
- See projector enclosure for safety related markings.
- The unit should only be repaired by appropriate service personnel.

- Only use attachments/accessories specified by the manufacturer.
- Do not look into straight into the projector lens during operation. The bright light may harm your eyes.
- When replacing the lamp, please allow the unit to cool down. Follow instructions as described on pages 58-60.
- This projector will detect the life of the lamp itself. Please be sure to change the lamp when it shows warning messages.
- Reset the "Lamp Reset" function from the on-screen display "Options|Lamp Settings" menu after replacing the lamp module (refer to page 49).
- When switching the projector off, please ensure the cooling cycle has been completed before disconnecting power. Allow 90 seconds for the projector to cool down.
- When the lamp is approaching to the end of its life time, the message "Lamp life exceeded." will show on the screen. Please contact your local reseller or service center to change the lamp as soon as possible.
- Turn off and unplug the power plug from the AC outlet before cleaning the product.
- Use a soft dry cloth with mild detergent to clean the display housing. Do not use abrasive cleaners, waxes or solvents to clean the unit.
- Disconnect the power plug from AC outlet if the product is not being used for a long period of time.

Note: *When the lamp reaches the end of its life, the projector will not turn back on until the lamp module has been replaced. To replace the lamp, follow the procedures listed under "Replacing the Lamp" section on pages 58-60.*

- *Do not setup the projector in places where it might be subjected to vibration or shock.*
- *Do not touch the lens with bare hands*
- *Remove battery/batteries from remote control before storage. If the battery/batteries are left in the remote for long periods, they may leak.*
- *Do not use or store the projector in places where smoke from oil or cigarettes may be present, as it can adversely affect the quality of the projector performance.*
- *Please follow the correct projector orientation installation as non standard installation may affect the projector performance.*
- *Use a power strip and or surge protector. As power outages and brown-outs can KILL devices.*

3D Safety Information

Please follow all warnings and precautions as recommended before you or your child use the 3D function.

Warning

Children and teenagers may be more susceptible to health issues associated with viewing in 3D and should be closely supervised when viewing these images.

Photosensitive Seizure Warning and Other Health Risks

- Some viewers may experience an epileptic seizure or stroke when exposed to certain flashing images or lights contained in certain Projector pictures or video games. If you suffer from, or have a family history of epilepsy or strokes, please consult with a medical specialist before using the 3D function.
- Even those without a personal or family history of epilepsy or stroke may have an undiagnosed condition that can cause photosensitive epileptic seizures.
- Pregnant women, the elderly, sufferers of serious medical conditions, those who are sleep deprived or under the influence of alcohol should avoid utilizing the unit's 3D functionality.
- If you experience any of the following symptoms, stop viewing 3D pictures immediately and consult a medical specialist: (1) altered vision; (2) light-headedness; (3) dizziness; (4) involuntary movements such as eye or muscle twitching; (5) confusion; (6) nausea; (7) loss of awareness; (8) convulsions; (9) cramps; and/ or (10) disorientation. Children and teenagers may be more likely than adults to experience these symptoms. Parents should monitor their children and ask whether they are experiencing these symptoms.

- Watching 3D projection may also cause motion sickness, perceptual after effects, disorientation, eye strain and decreased postural stability. It is recommended that users take frequent breaks to lessen the potential of these effects. If your eyes show signs of fatigue or dryness or if you have any of the above symptoms, immediately discontinue use of this device and do not resume using it for at least thirty minutes after the symptoms have subsided.
- Watching 3D projection while sitting too close to the screen for an extended period of time may damage your eyesight. The ideal viewing distance should be at least three times the screen height. It is recommended that the viewer's eyes are level with the screen.
- Watching 3D projection while wearing 3D glasses for an extended period of time may cause a headache or fatigue. If you experience a headache, fatigue or dizziness, stop viewing the 3D projection and rest.
- Do not use the 3D glasses for any other purpose than for watching 3D projection.
- Wearing the 3D glasses for any other purpose (as general spectacles, sunglasses, protective goggles, etc.) may be physically harmful to you and may weaken your eyesight.
- Viewing in 3D projection may cause disorientation for some viewers. Accordingly, DO NOT place your 3D PROJECTOR near open stairwells, cables, balconies, or other objects that can be tripped over, run into, knocked down, broken or fallen over.

Copyright

This publication, including all photographs, illustrations and software, is protected under international copyright laws, with all rights reserved. Neither this manual, nor any of the material contained herein, may be reproduced without written consent of the author.

© Copyright 2015

Disclaimer

The information in this document is subject to change without notice. The manufacturer makes no representations or warranties with respect to the contents hereof and specifically disclaims any implied warranties of merchantability or fitness for any particular purpose. The manufacturer reserves the right to revise this publication and to make changes from time to time in the content hereof without obligation of the manufacturer to notify any person of such revision or changes.

Trademark Recognition

Kensington is a U.S. registered trademark of ACCO Brand Corporation with issued registrations and pending applications in other countries throughout the world.

HDMI, the HDMI Logo, and High-Definition Multimedia Interface are trademarks or registered trademarks of HDMI Licensing LLC in the United States and other countries.

DLP®, DLP Link and the DLP logo are registered trademarks of Texas Instruments and BrilliantColor™ is a trademark of Texas Instruments.

All other product names used in this manual are the properties of their respective owners and are Acknowledged.

FCC

This device has been tested and found to comply with the limits for a Class B digital device pursuant to Part 15 of the FCC rules. These limits are designed to provide reasonable protection against harmful interference in a residential installation. This device generates, uses and can radiate radio frequency energy and, if not installed and used in accordance with the instructions, may cause harmful interference to radio communications.

However, there is no guarantee that interference will not occur in a particular installation. If this device does cause harmful interference to radio or television reception, which can be determined by turning the device off and on is encouraged to try to correct the interference by one or more of the following measures:

- Reorient or relocate the receiving antenna.
- Increase the separation between the device and receiver.
- Connect the device into an outlet on a circuit different from that to which the receiver is connected.
- Consult the dealer or an experienced radio/television technician for help.

Notice: Shielded cables

All connections to other computing devices must be made using shielded cables to maintain compliance with FCC regulations.

Caution

Changes or modifications not expressly approved by the manufacturer could void the user's authority, which is granted by the Federal Communications Commission, to operate this projector.

Operation Conditions

This device complies with Part 15 of the FCC Rules. Operation is subject to the following two conditions:

1. This device may not cause harmful interference and
2. This device must accept any interference received, including interference that may cause undesired operation.

Notice: Canadian users

This Class B digital apparatus complies with Canadian ICES-003.

Remarque à l'intention des utilisateurs canadiens

Cet appareil numérique de la classe B est conforme à la norme NMB-003 du Canada.

Declaration of Conformity for EU countries

- EMC Directive 2004/108/EC (including amendments)
- Low Voltage Directive 2006/95/EC
- R & TTE Directive 1999/5/EC (if product has RF function)

WEEE



Disposal instructions

Do not throw this electronic device into the trash when discarding. To minimize pollution and ensure utmost protection of the global environment, please recycle it.

INTRODUCTION

Package Overview

Carefully unpack and verify that you have the items listed below under standard accessories. Some of the items under optional accessories may not be available depending on the model, specification and your region of purchase. Please check with your place of purchase. Some accessories may vary from region to region.

The warranty card is only supplied in some specific regions. Please consult your dealer for detailed information.

Standard accessories

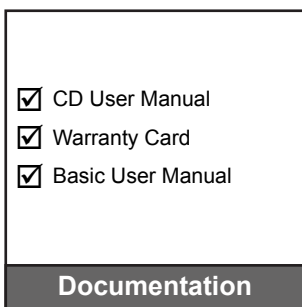
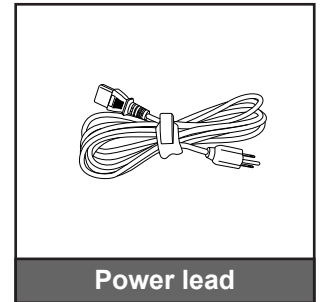
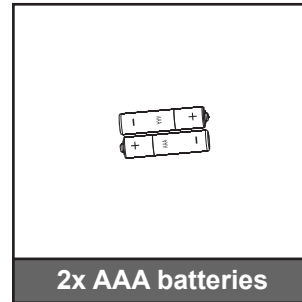
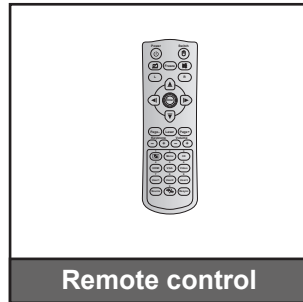
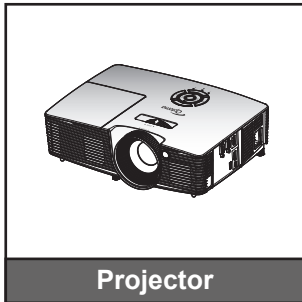

Optional accessories

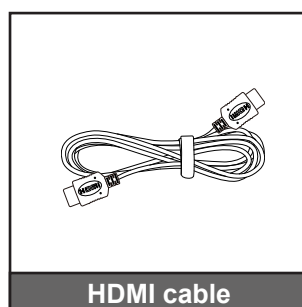
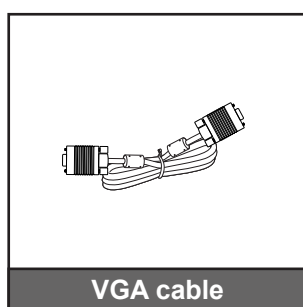

Note: Optional accessories vary depending on model, specification and region.

INTRODUCTION

Product Overview

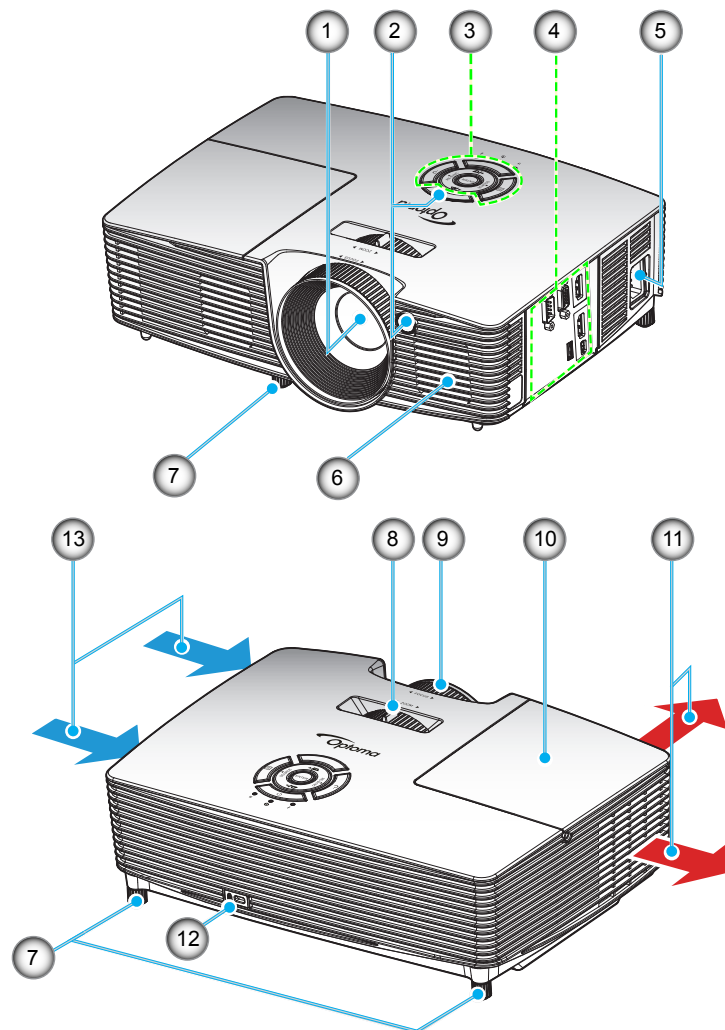

Note: Do not block projector inlet or outlet air vents.

(*) optional accessory varies depending on model, specification, and region.

No	Item	No	Item
1.	Lens	8.	Zoom Lever
2.	IR Receiver	9.	Focus Ring
3.	Keypad	10.	Lamp Cover
4.	Input / Output	11.	Ventilation (outlet)
5.	Power Socket	12.	Kensington™ Lock Port
6.	Speaker	13.	Ventilation (inlet)
7.	Tilt-Adjustment Feet		

INTRODUCTION

Connections

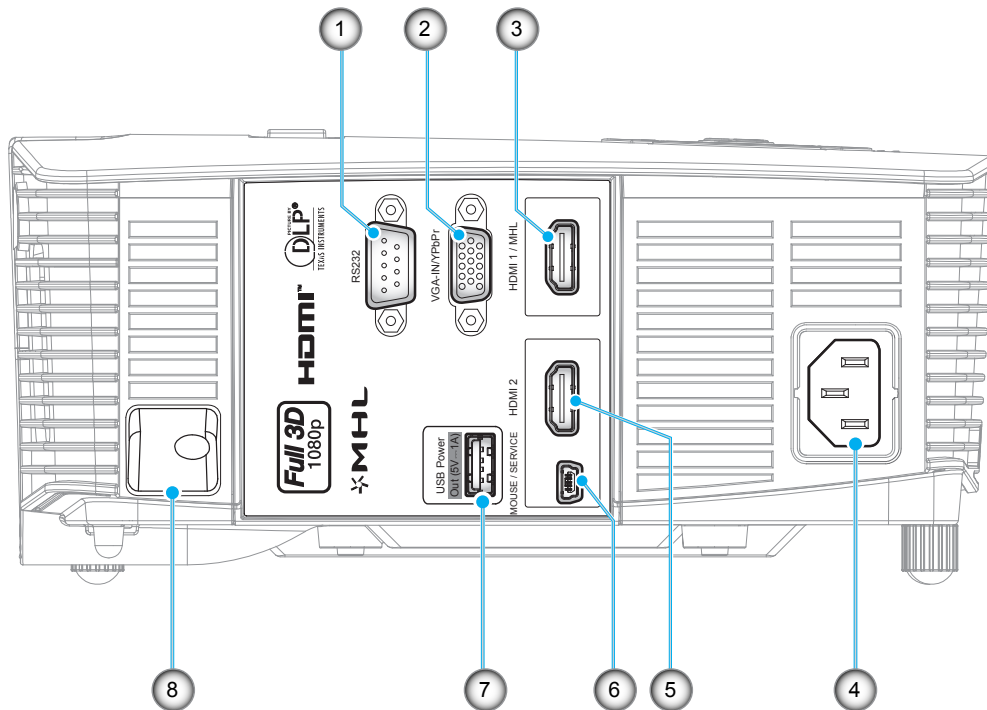

Note: Remote mouse requires special remote control.

No	Item	No	Item
1.	RS-232 Connector	5.	HDMI 2 Connector
2.	VGA-IN / YPbPr Connector	6.	MOUSE / SERVICE Connector
3.	HDMI 1 / MHL Connector	7.	USB Power Out (5V---1A) Connector
4.	Power Socket	8.	Security Bar

INTRODUCTION

Keypad

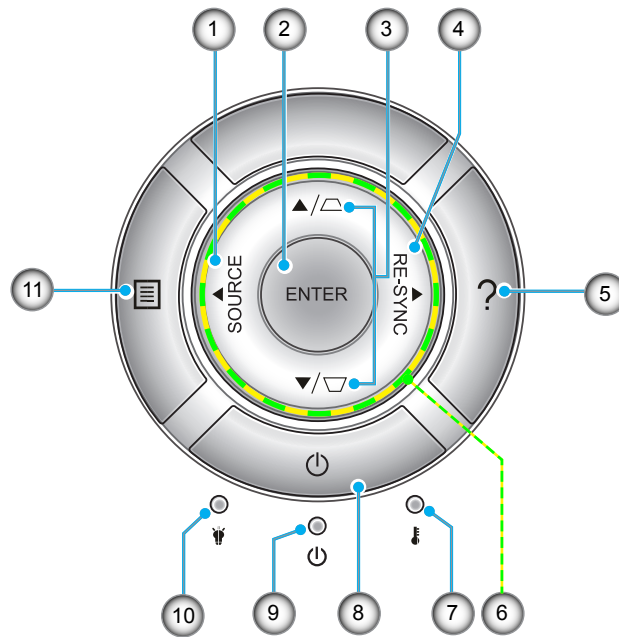

No	Item	No	Item
1.	Source	7.	Temp LED
2.	Enter	8.	Power
3.	Keystone Correction	9.	On/Standby LED
4.	Re-Sync	10.	Lamp LED
5.	Help	11.	Menu
6.	Four Directional Select Keys		

INTRODUCTION

Remote control

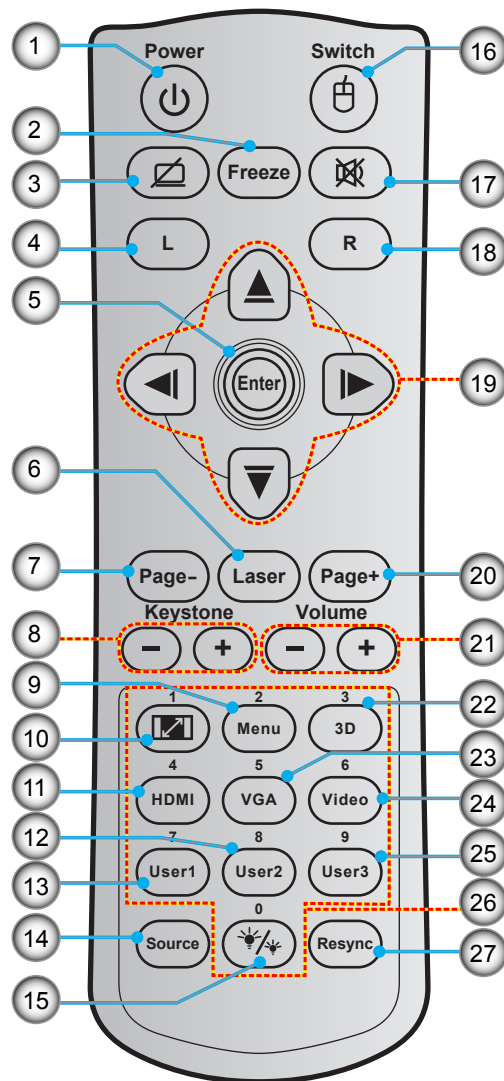

No	Item	No	Item
1.	Power On / Off	15.	Brightness Mode
2.	Freeze	16.	Mouse On / Off
3.	Display Blank / Audio Mute	17.	Mute
4.	Mouse Left Click	18.	Mouse Right Click
5.	Enter	19.	Four Directional Select Keys
6.	Laser	20.	Page +
7.	Page -	21.	Volume - / +
8.	Keystone - / +	22.	3D Menu On / Off
9.	Menu	23.	VGA
10.	Aspect Ratio	24.	Video
11.	HDMI	25.	User 3
12.	User 2	26.	Numeric Keypad (0-9)
13.	User 1	27.	Resync
14.	Source		

Note: Some keys may have no function for models that do not support these features.

SETUP AND INSTALLATION

Installing the projector

Your projector is designed to be installed in one of four possible positions.

Your room layout or personal preference will dictate which installation location you select. Take into consideration the size and position of your screen, the location of a suitable power outlet, as well as the location and distance between the projector and the rest of your equipment.

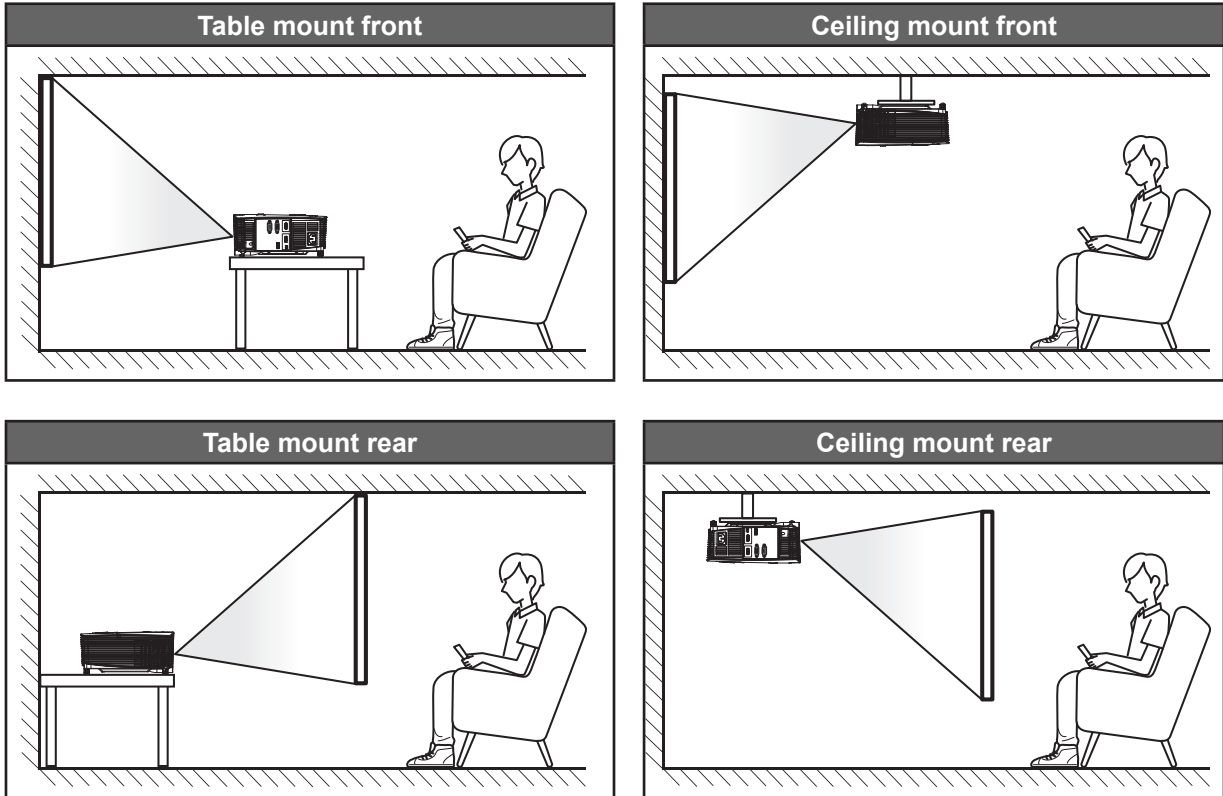

Projector should be placed flat on a surface and 90 degrees / perpendicular to the to the screen.

- How to determine projector location for a given screen size, please refer to distance table on page 64.
- How to determine screen size for a given distance, please refer to distance table on page 64.

Note: The further away the projector is placed from the screen the projected image size increases and vertical offset also increases proportionally.

IMPORTANT!

Do not operate the projector in any orientation other than table top or ceiling mount. The projector should be horizontal and not tilted either forwards/backwards or left/right. Any other orientation will invalidate the warranty and may shorten the lifetime of the projector lamp or the projector itself. For non standard installation advise please contact Optoma.

SETUP AND INSTALLATION

Connecting sources to the projector

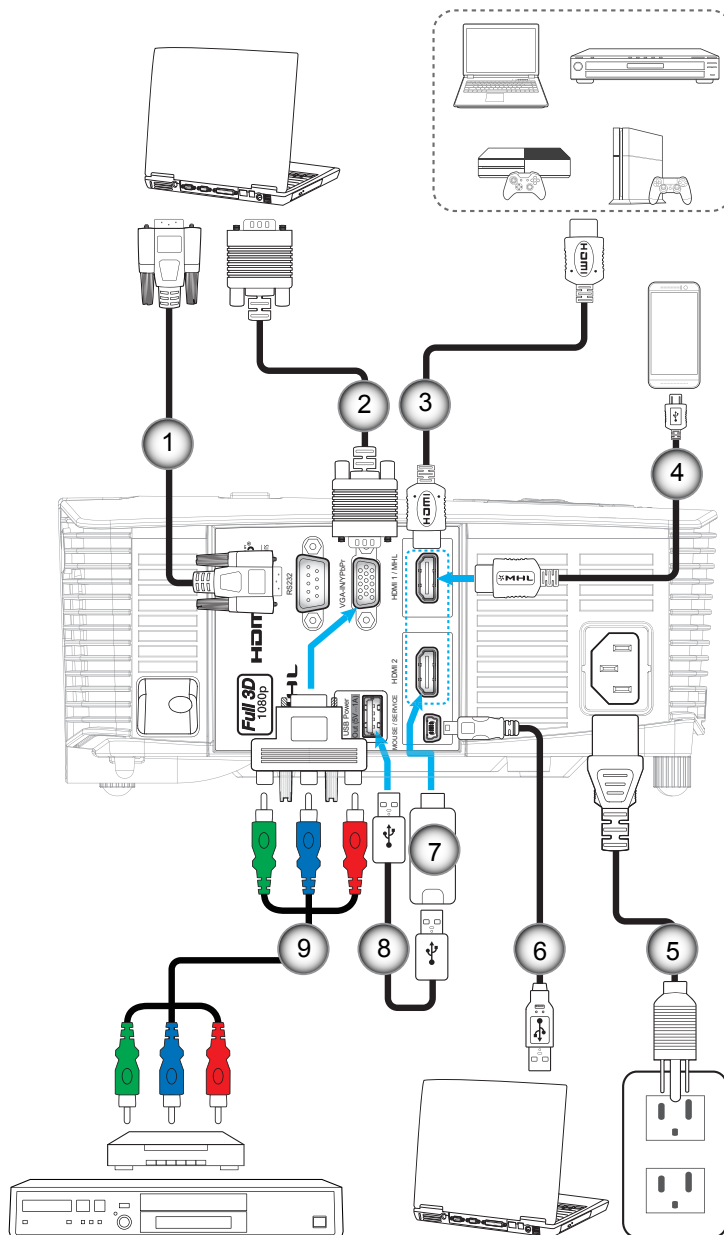

No	Item	No	Item
1.	RS232 Cable	6.	USB Cable (mouse control)
2.	VGA In Cable	7.	HDMI Dongle
3.	HDMI Cable	8.	USB Power Cable
4.	MHL Cable	9.	RCA Component Cable
5.	Power Cord		

SETUP AND INSTALLATION

Adjusting the projector image

Image height

The projector is equipped with elevator feet for adjusting the image height.

1. Locate the adjustable foot you wish to adjust on the underside of the projector.
2. Rotate the adjustable foot clockwise or counterclockwise to raise or lower the projector.

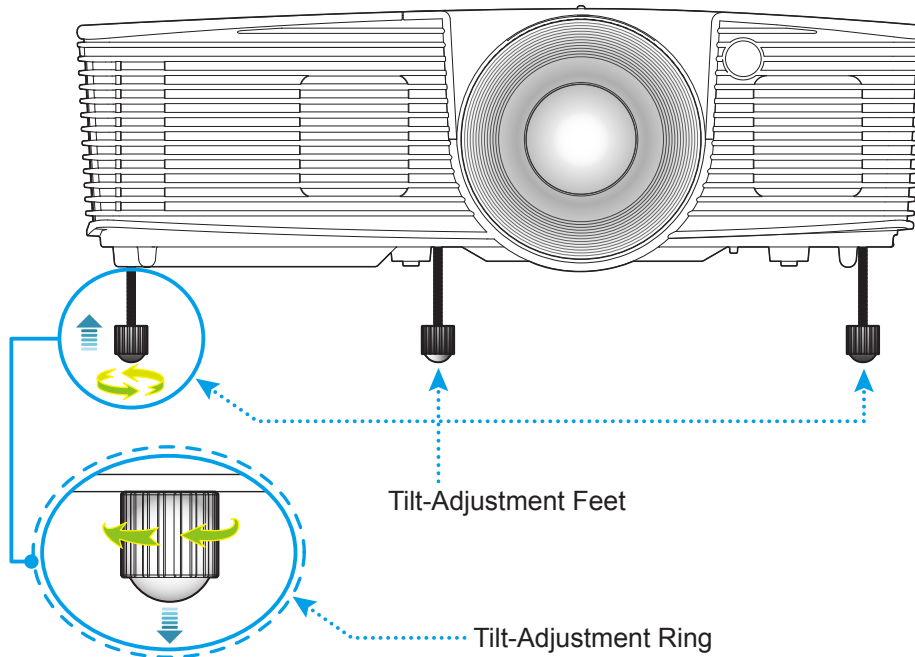

Zoom and focus

- To adjust the image size, turn the zoom lever clockwise or counterclockwise to increase or decrease the projected image size.
- To adjust the focus, turn the focus ring clockwise or counterclockwise until the image is sharp and legible.

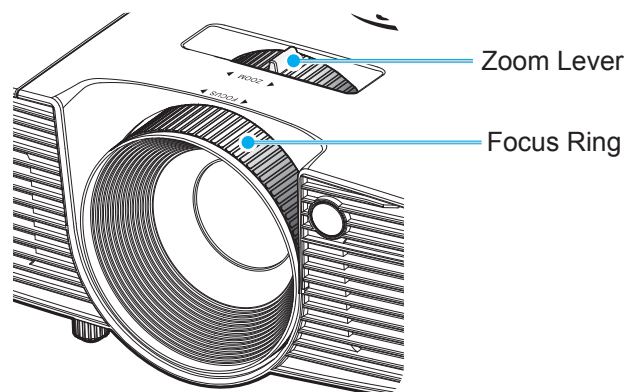

Note: The projector will focus at a distance of 1.5m to 10m.

SETUP AND INSTALLATION

Remote setup

Installing / replacing the batteries

Two AAA size batteries are supplied for the remote control.

1. Remove the battery cover on the back of the remote control.
2. Insert AAA batteries in the battery compartment as illustrated.
3. Replace back cover on remote control.

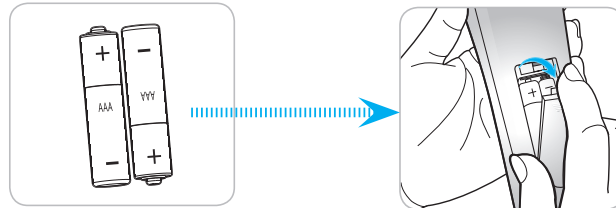

Note: Replace only with the same or equivalent type batteries.

CAUTION

Improper use of batteries can result in chemical leakage or explosion. Be sure to follow the instructions below.

- Do not mix batteries of different types. Different types of batteries have different characteristics.
- Do not mix old and new batteries. Mixing old and new batteries can shorten the life of new batteries or cause chemical leakage in old batteries.
- Remove batteries as soon as they are depleted. Chemicals that leak from batteries that come in contact with skin can cause a rash. If you find any chemical leakage, wipe thoroughly with a cloth.
- The batteries supplied with this product may have a shorter life expectancy due to storage conditions.
- If you will not be using the remote control for an extended period of time, remove the batteries.
- When you dispose of the batteries, you must obey the law in the relative area or country.

Effective range

Infra-Red (IR) remote control sensor is located on the rear side of the projector. Ensure to hold the remote control at an angle within 30 degrees perpendicular to the projector's IR remote control sensor to function correctly. The distance between the remote control and the sensor should not be longer than 8 meters (~ 26 feet).

- Make sure that there are no obstacles between the remote control and the IR sensor on the projector that might obstruct the infra-red beam.
- Make sure the IR transmitter of the remote control is not being shined by sunlight or fluorescent lamps directly.
- Please keep the remote controller away from fluorescent lamps for over 2 m or the remote controller might become malfunction.
- If the remote control is closed to Inverter-Type fluorescent lamps, it might become ineffective from time to time.
- If the remote control and the projector are within a very short distance, the remote control might become ineffective.
- When you aim at the screen, the effective distance is less than 5 m from the remote control to the screen and reflecting the IR beams back to the projector. However, the effective range might change according to screens.

SETUP AND INSTALLATION

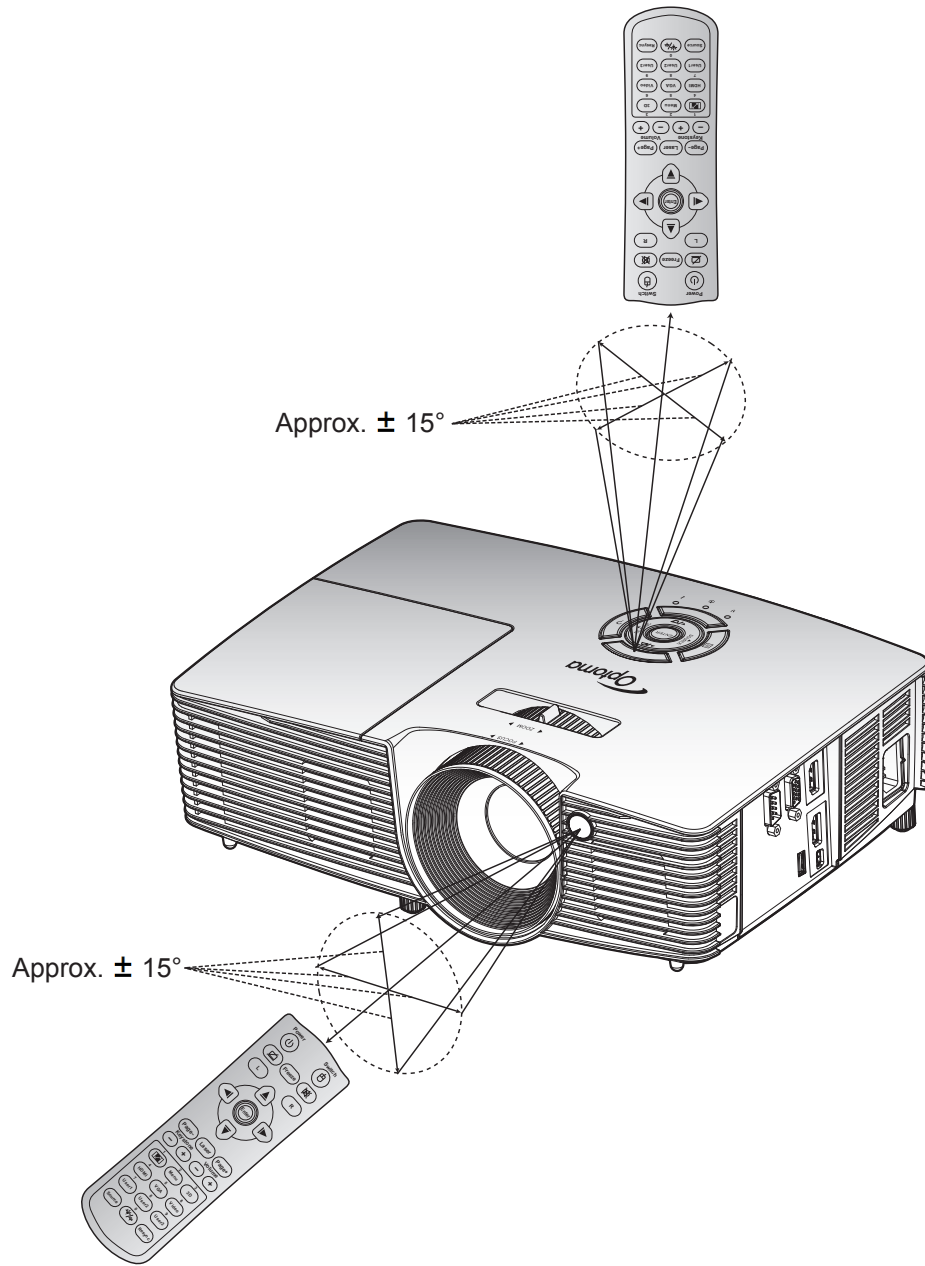

USING THE PROJECTOR

Powering on / off the projector

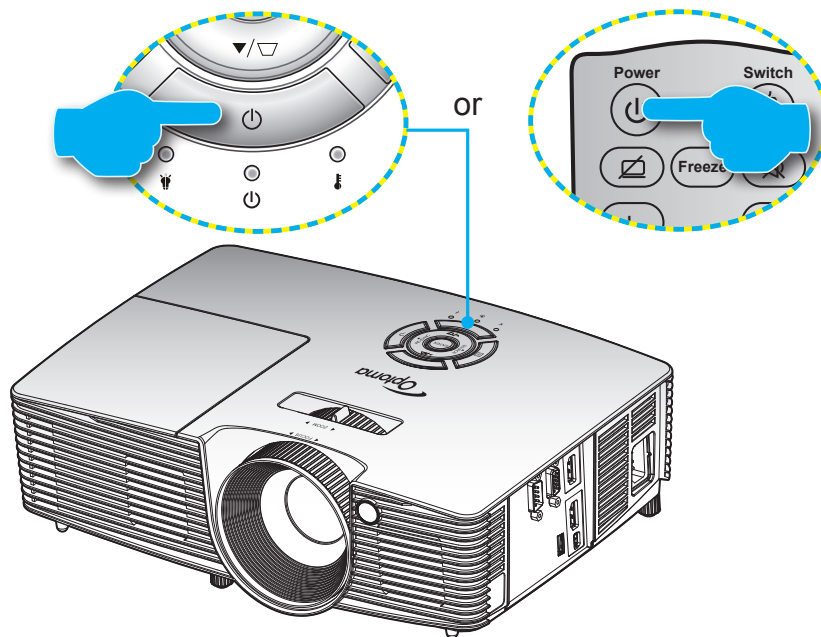

Powering on

1. Securely connect the power lead and signal/source cable. When connected, the On/Standby LED will turn red.
2. Turn on the projector by pressing the "⏻" either on the projector keypad or the remote control.
3. A start up screen will display in approximately 10 seconds and the On/Standby LED will be flashing green or blue.

Note: *The first time the projector is turned on, you will be prompted to select the preferred language, projection orientation, and other settings.*

USING THE PROJECTOR

Powering off

1. Turn off the projector by pressing the "⏻" either on the projector keypad or the remote control.
2. The following message will be displayed:

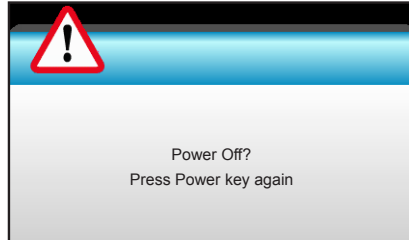

3. Press the "⏻" again to confirm, otherwise the message will disappear after 15 seconds. When you press the "⏻" button for the second time, the projector will shut down.
4. The cooling fans will continue to operate for about 10 seconds for the cooling cycle and the On/Standby LED will flash green or blue. When the On/Standby LED turns solid red, this indicates the projector has entered standby mode. If you wish to turn the projector back on, you must wait until the cooling cycle has finished and the projector has entered standby mode. When the projector is in standby mode, simply press the "⏻" button again to turn on the projector.
5. Disconnect the power lead from the electrical outlet and the projector.

Note: *It is not recommended that the projector is turned on immediately, right after a power off procedure.*

USING THE PROJECTOR

Selecting an input source

Turn on the connected source that you want to display on the screen, such as computer, notebook, video player, etc. The projector will automatically detect the source. If multiple sources are connected, push the source button on the projector keypad or the remote control to select the desired input.

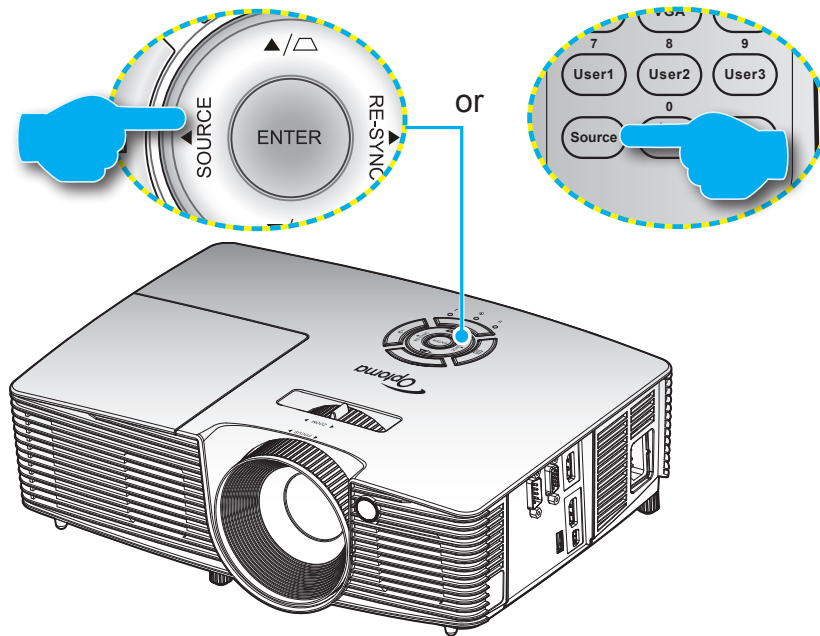

USING THE PROJECTOR

Menu navigation and features

The projector has multilingual on-screen display menus that allow you to make image adjustments and change a variety of settings. The projector will automatically detect the source.

1. To open the OSD menu, press "Menu" on the remote control or the projector keyboard.
2. When OSD is displayed, use ◀▶ keys to select any item in the main menu. While making a selection on a particular page, press ▼ or "Enter" key to enter sub menu.
3. Use ▲ ▼ keys to select the desired item in the sub menu and then press ▶ or "Enter" key to view further settings. Adjust the settings by using ◀▶ keys.
4. Select the next item to be adjusted in the sub menu and adjust as described above.
5. Press "Enter" or "Menu" to confirm, and the screen will return to the main menu.
6. To exit, press "Menu" again. The OSD menu will close and the projector will automatically save the new settings.

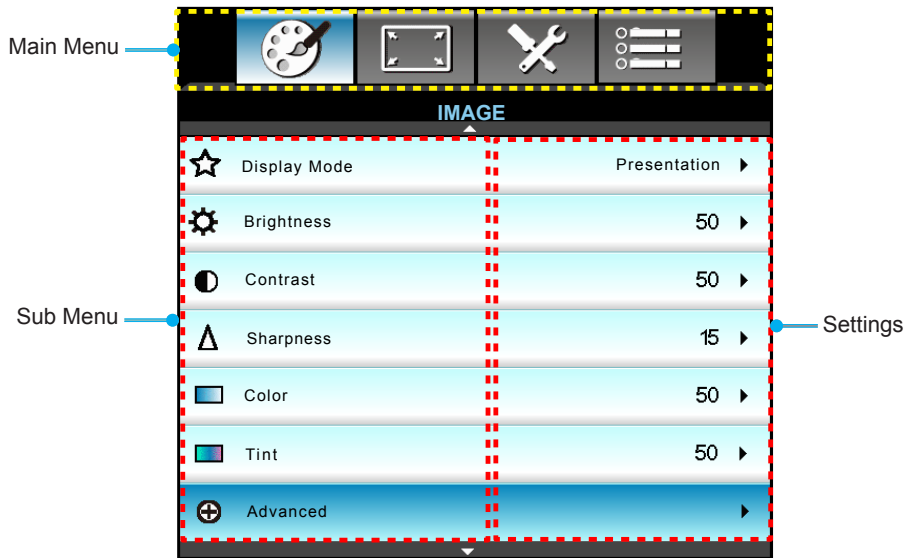

USING THE PROJECTOR









OSD Menu tree

Main Menu	Sub Menu	Sub Menu 2	Sub Menu 3	Sub Menu 4	Values		
Image	Display Mode				Presentation		
					Bright		
					Movie		
					sRGB		
					Blackboard		
					User		
					3D		
					Vivid mode		
	Brightness				-50~50		
	Contrast				-50~50		
	Sharpness				1 ~15		
	Color				-50~50		
	Tint				-50~50		
	Advanced	Noise Reduction				0~10	
			Gamma	Film			
				Video			
				Graphics			
		Standard					
		BrilliantColor™				1 ~ 10	
		Color Temp.				Warm	
						Medium	
						Cold	
		Color Matching	Red		Hue		-50~50
					Saturation		-50~50
					Gain		-50~50
			Green		Hue		-50~50
					Saturation		-50~50
					Gain		-50~50
			Blue		Hue		-50~50
					Saturation		-50~50
					Gain		-50~50
			Cyan		Hue		-50~50
					Saturation		-50~50
					Gain		-50~50
			Magenta		Hue		-50~50
					Saturation		-50~50
				Gain		-50~50	
Yellow			Hue		-50~50		
			Saturation		-50~50		
			Gain		-50~50		
White			Red		-50~50		
			Green		-50~50		
			Blue		-50~50		

USING THE PROJECTOR

Main Menu	Sub Menu	Sub Menu 2	Sub Menu 3	Sub Menu 4	Values	
Image	Advanced	Color Matching	Reset			
			Exit			
		Color Space			HDMI Input: Auto/ RGB(0~255) / RGB(16~235)/ YUV	
		Signal	Automatic		On / Off	
			Phase (VGA)		0~31	
			Frequency (VGA)		-5~5	
			H. Position (VGA)		-5~5	
			V. Position (VGA)		-5~5	
			Exit			
		Reset			Yes/ No	
Exit						
Display	Format				4:3	
					16:9	
					LBX	
					Native	
					Auto	
	Edge Mask				0~10	
	Zoom				-5~25	
	Image Shift	H		Right/Left (Icon in center)	-100~+100	
		V		Up/Down (Icon in center)	-100~+100	
	V Keystone				-40~+40	
	3D	3D Mode				Off
						DLP-Link
						IR
		3D Format				Auto
						SBS
						Top and Bottom
						Frame Sequential
3D→2D					3D	
					L	
					R	
3D Sync Invert				On		
				Off		
Setup	Language				English	
					Deutsch	
					Français	
					Italiano	
					Español	
					Português	
					Svenska	
					Nederland	

USING THE PROJECTOR

Main Menu	Sub Menu	Sub Menu 2	Sub Menu 3	Sub Menu 4	Values	
Setup	Language				Norsk	
					Dansk	
					Polski	
					Русский	
					Suomi	
					Ελληνικά	
					Magyar	
					Čeština	
					عربي	
					繁體中文	
					简体中文	
					日本語	
					한국어	
					ไทย	
					Türkçe	
					Farsi	
					Tiếng Việt	
				Română		
				Bahasa Indonesia		
		Projection				
						
						
						
		Menu Location				
						
						
						
		Audio Settings	Mute			On
						Off
			Volume			0-10
		Security →	Security	On		
				Off		
			Security Timer	Month		
				Day		
				Hour		
				Change Password		
		Exit				

USING THE PROJECTOR

Main Menu	Sub Menu	Sub Menu 2	Sub Menu 3	Sub Menu 4	Values	
Setup	Projector ID				00~99	
	Advanced	Logo			Default	
					Neutral	
					User	
		Logo capture				
Exit						
Options	Input Source				VGA	
					HDMI1	
					HDMI2	
	Source Lock				On	
					Off	
	High Altitude				On	
					Off [Default]	
	Information Hide				On	
					Off [Default] Note: <i>The Warning and Power off message will not be hidden.</i>	
	Keypad Lock				On	
					Off [Default]	
	Test Pattern				None	
					Grid	
					White Pattern	
	IR Function				On	
					Front	
					Top	
					Off [Default]	
	Background Color				Black [Default]	
					Red	
					Blue	
					Green	
					White	
	Lamp Settings	Lamp Hour				
						On [default]
		Lamp Reminder				Off
						Bright
Lamp Mode					Eco	
					Dynamic	
					ECO+	
Lamp Reset					Yes	
				No		
Dynamic Dimming	ON					
	OFF					

USING THE PROJECTOR

Main Menu	Sub Menu	Sub Menu 2	Sub Menu 3	Sub Menu 4	Values			
Options	HDMI Link Settings	HDMI Link			Off			
					On			
		Inclusive of TV			Yes			
					No			
		Power On Link			Mutual			
					PJ→Device			
					Device→PJ			
		Power Off Link			Off			
					On			
		Exit						
		Remote Settings	USER 1			<Default: HDMI2 >	HDMI 2	
							Brightness	
						Contrast		
						Sleep Timer		
						Test Pattern		
						MHL		
	USER 2				<Default: MHL>	HDMI 2		
						Brightness		
						Contrast		
						Sleep Timer		
						Test Pattern		
						MHL		
	USER 3				<Default: Sleep Timer>	HDMI 2		
						Brightness		
						Contrast		
						Sleep Timer		
						Test Pattern		
						MHL		
	Optional Filter Settings		Optional Filter Installed				Yes	
							No	
			Filter Usage Hours					Read-Only [Range 0~ 9999]
								Off
								300 hr
								500 hr [Default]
		Filter Reminder					800 hr	
							1000 hr	
		Filter Reset			Yes		Yes	
				No		No		
	Exit							

USING THE PROJECTOR

Main Menu	Sub Menu	Sub Menu 2	Sub Menu 3	Sub Menu 4	Values
Options	Advanced	Direct Power On			On
					Off
		Auto Power Off (min.)			0-180 Note: One step is 5 minutes; default is 20 minutes.
					0-990 Note: One step is 30 minutes.
		Quick Resume	On		
	Off [Default]				
	Power Mode (Standby)			Active	
				Eco	
	Reset		Yes		
			No		

Note:

- If the Signal setting is set to Automatic, the Phase, frequency items are grayed out. If the “Signal” setting is set to a specific input source, the phase, frequency items will appear for user to manually tune and saved in settings.
- The “LAMP RESET” in OSD will only reset both Lamp Hours in OSD and Lamp Hours in service mode. The Projection Hours in service mode will not be reset.
- When you made the changes on the “IR Function”, “Projection”, or “Keypad Lock” function, a confirmation message will appear on the screen. Select “Yes” to save the settings.
- Each display mode can be adjusted and saved the value.
- In 3D timing mode, the zoom/edge mask will be disabled to prevent from image break.

USING THE PROJECTOR

Image menu

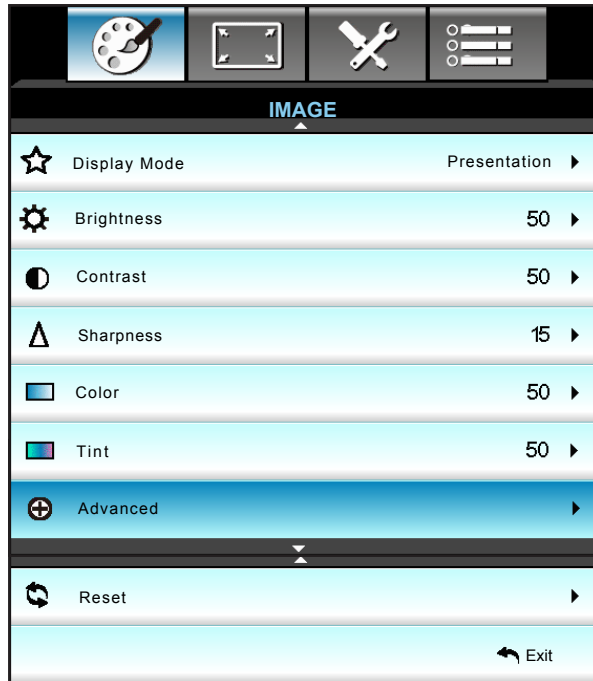

Display Mode

There are many factory presets optimized for various types of images.



- **Presentation:** This mode is suitable for showing PowerPoint presentations when the projector is connected to the PC.
- **Bright:** Maximum brightness from PC input.
- **Movie:** This mode is suitable for watching video.
- **sRGB:** Standardized accurate color.
- **Blackboard:** This mode should be selected to achieve optimum color settings when projecting onto a blackboard (green).
- **Vivid:** In this mode, the color saturation and brightness are well-balanced. Choose this mode for playing games.

USING THE PROJECTOR

- **3D:** To experience the 3D effect, you need to have 3D glasses. Make sure your PC/portable device has a 120 Hz signal output quad buffered graphics card and a 3D Player installed.
- **User:** Memorize user's settings.

Brightness

Adjust the brightness of the image.



- Press the ◀ to darken image.
- Press the ▶ to lighten the image.

Contrast



The contrast controls the degree of difference between the lightest and darkest parts of the picture.

- Press the ◀ to decrease the contrast.
- Press the ▶ to increase the contrast.

Sharpness

Adjust the sharpness of the image.



- Press the ◀ to decrease the sharpness.
- Press the ▶ to increase the sharpness.

Color

Adjust a video image from black and white to fully saturated color.



- Press the ◀ to decrease the amount of saturation in the image.
- Press the ▶ to increase the amount of saturation in the image.

Tint

Adjust the color balance of red and green.



- Press the ◀ to increase the amount of green in the image.
- Press the ▶ to increase the amount of red in the image.

USING THE PROJECTOR

Reset

Choose "Yes" to return the factory default settings for "IMAGE".



Exit

Choose "Exit" to exit the menu.

USING THE PROJECTOR

Image advanced menu

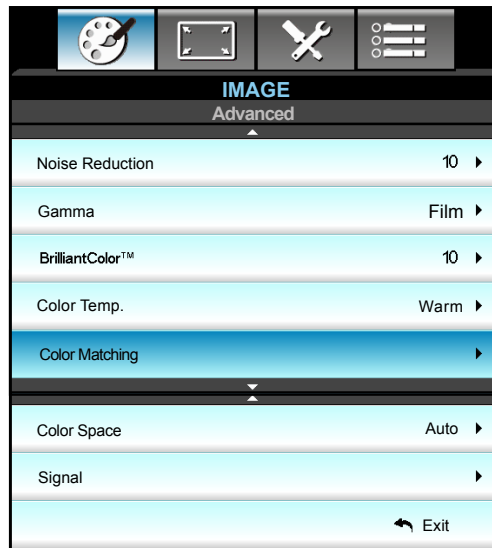

Noise Reduction

Select a filter sensitivity to be applied on noise. A higher value may improve noisy sources, but it will soften the image.



- Press the ◀ to decrease the noise in the image.
- Press the ▶ to increase the noise in the image.

Gamma

This allows you to set up gamma curve type. After the initial setup and fine tuning is completed, utilize the Gamma Adjustment steps to optimize your image output.



- Film: for home theater.
- Video: for video or TV source.
- Graphics: for PC / Photo source.
- Standard: for standardized setting.
- Press the ◀ or ▶ to select the mode.

BrilliantColor™

This adjustable item utilizes a new color-processing algorithm and enhancements to enable higher brightness while providing true, more vibrant colors in picture.



- Press the ▶ to stronger enhance the image.
- Press the ◀ to less enhance the image.

USING THE PROJECTOR

Color Temp.

Press the ◀ or ▶ to select a color temperature from Warm, Medium, or Cold.



Color Matching

Press the ▶ into the next menu and then use ▲, ▼, ◀, or ▶ to select the item.



- Red/Green/Blue/Cyan/Magenta/Yellow/White: Use ◀ or ▶ to adjust Hue, Saturation, or Gain Colors.

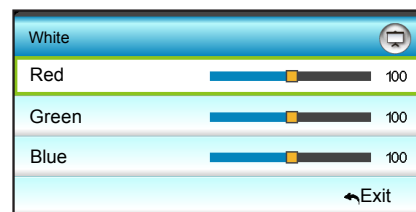
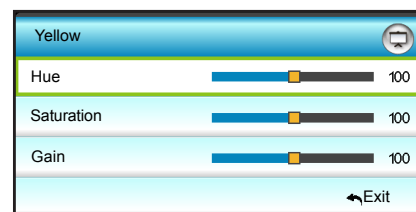
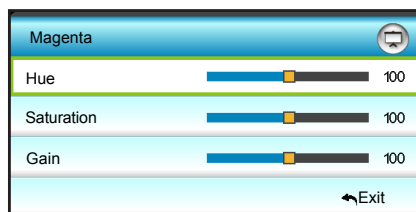
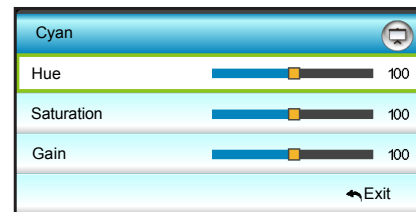
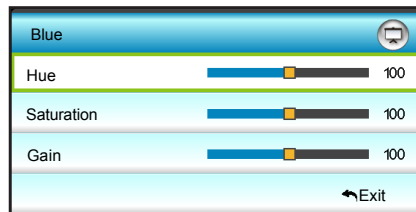
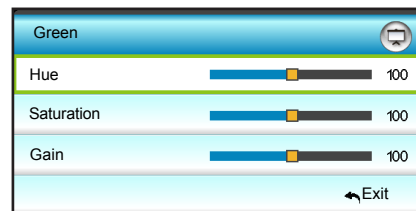
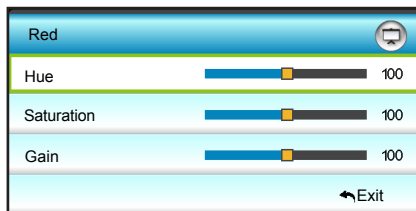

Color Space

Press the ◀ or ▶ to select an appropriate color matrix type from the following:



- HDMI Input: Auto, RGB(0-255), RGB(16-235), or YUV.

USING THE PROJECTOR

Reset

Choose “↺ Reset” to return the factory default settings for color adjustments.

Exit

Choose “Exit” to exit the menu.

USING THE PROJECTOR

Image advanced signal menu

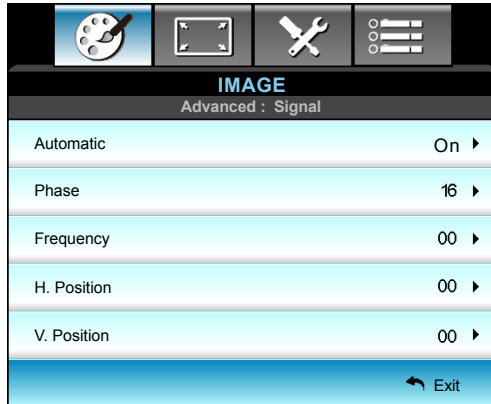

Note:

- "Signal" is only supported in Analog VGA (RGB) signal.
- If the "Signal" setting is set to automatic, the phase, frequency items are grayed out. If the "Signal" setting is set to a specific input source, the phase, frequency items will appear for the user to manually tune and are saved in the settings after the next time projector is turned off and on again.

Automatic

Automatically selects the signal. If this function is enabled, the Phase, frequency items are grayed out. If this function is disabled, the phase, frequency items will appear for user to manually tune and saved in settings after the next time projector turns off and on again.



Phase (VGA)

Synchronize the signal timing of the display with the graphic card. If the image appears to be unstable or flickers, use this function to correct it.



Frequency (VGA)

Change the display data frequency to match the frequency of your computer's graphic card. Use this function only if the image appears flickering vertical lines.



H. Position (VGA)

- Press the ◀ to move the image left.
- Press the ▶ to move the image right.



USING THE PROJECTOR

V. Position (VGA)

- Press the ◀ to move the image down.
- Press the ▶ to move the image up.



Exit

Choose "Exit" to exit the menu.

USING THE PROJECTOR

Display menu



Format

Press the ◀ or ▶ to choose your desired aspect ratio between 4:3, 16:9, LBX, Native, Auto.



- 4:3: This format is for 4:3 input sources.
- 16:9: This format is for 16:9 input sources, like HDTV and DVD enhanced for Wide screen TV.
- LBX: This format is for non-16x9, letterbox source and for users who use external 16x9 lens to display 2.35:1 aspect ratio using full resolution.
- Native: This format displays the original image without any scaling.
- AUTO: Automatically selects the appropriate display format.

Note: Detailed informations about LBX mode:

- Some Letter-Box Format DVDs are not enhanced for 16x9 TVs. In this situation, the image will not look right when displaying image in 16:9 mode. In this situation, please try to use the 4:3 mode to view the DVD. If the content is not 4:3, there will be black bars around the image in 16:9 display. For this type of content, you can use LBX mode to fill the image on the 16:9 display.
- If you use an external anamorphic lens, this LBX mode also allows you to watch a 2.35:1 content (include Anamorphic DVD and HDTV film source) that supports anamorphic wide is enhanced for 16x9 Display in a wide 2.35:1 image. In this case, there are no black bars. Lamp power and vertical resolution are fully utilized.

1080P scaling table:

16 : 9 screen	480i/p	576i/p	1080i/p	720p	PC
4x3	Scale to 1440x1080.				
16x9	Scale to 1920x1080.				
LBX	Scale to 1920x1440, then get the central 1920x1080 image to display.				
Native mode	1:1 mapping centered. No scaling will be made; the image is displayed with the resolution based on input source.				
Auto	-If this format is selected, the Screen type will automatically become 16:9 (1920x1080). -If source is 4:3, the Screen type will automatically resize to 1440x1080. -If source is 16:9, the Screen type will automatically resize to 1920x1080. -If source is 16:10, the Screen type will automatically resize to 1920x1200 and cut 1920x1080 area to display.				

USING THE PROJECTOR

Edge Mask

Use this function to remove the video encoding noise on the edge of video source.



Note:

- Each I/O has different setting of "Edge Mask".
- "Edge Mask" and "Zoom" cannot work at the same time.

Zoom

- Press the ◀ to reduce the size of an image.
- Press the ▶ to magnify an image on the projection screen.



Image Shift

Press the ▶ into the next menu as below and then use the ▲, ▼, ◀, or ▶ to select item.

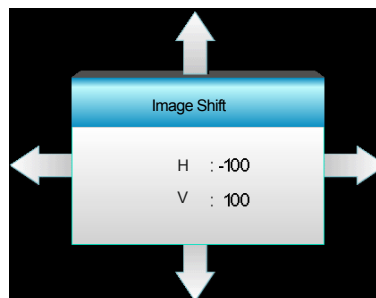

- H: Press the ◀▶ to shift the projected image position horizontally.
- V: Press the ▲ ▼ to shift the projected image position vertically.

V Keystone

Press the ◀ or ▶ to adjust image distortion vertically and make a squarer image.



USING THE PROJECTOR

Display 3D menu

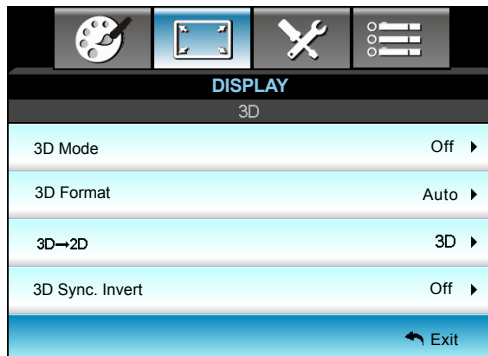

3D Mode

Use this option to disable the 3D function or select the appropriate the 3D function.

- Off: Select "Off" to turn off 3D mode.
- DLP-Link: Select "DLP-Link" to use optimized settings for DLP Link 3D Glasses.
- IR: Select "IR" to use optimized setting for IR 3D Glasses.

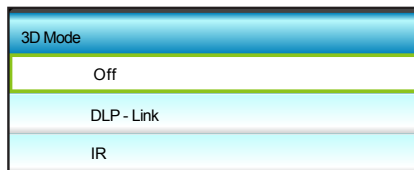

3D Format

Use this option to select the appropriate 3D format content.

- Auto: When a 3D identification signal is detected, the 3D format is selected automatically.
- SBS: Display 3D signal in "Side-by-Side" format.
- Top and Bottom: Display 3D signal in "Top and Bottom" format.
- Frame Sequential: Display 3D signal in "Frame Sequential" format.

Note:

- "3D Format" is only supported on 3D Timing on page 63.
- "3D Format" is only supported on non-HDMI 1.4a 3D timing.



3D→2D

Use this option to specify how the 3D content should appear on the screen.

- 3D: Display 3D signal.
- L (Left): Display the left frame of 3D content.
- R (Right): Display the right frame of 3D content.

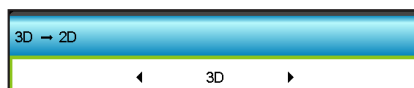

USING THE PROJECTOR

3D Sync. Invert

Use this option to enable/disable the 3D sync invert function.

- Press the "On" to invert left and right frame contents.
- Press the "Off" for default frame contents.



Exit

Choose "Exit" to exit the menu.

USING THE PROJECTOR

Setup menu







Language

Choose the multilingual OSD menu. Press ► into the sub menu and then use the ▲, ▼, ◀, or ▶ key to select your preferred language. Press "Enter" to finalize the selection.

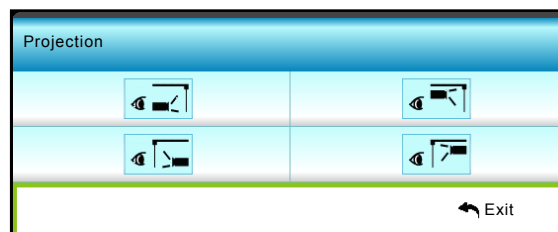

Projection



-  Front-Projection
This is the default selection. The image is projected straight on the screen.
-  Rear-Desktop
When selected, the image will appear reversed.
-  Front-Ceiling
When selected, the image will turn upside down.
-  Rear-Ceiling

USING THE PROJECTOR

When selected, the image will appear reversed in upside down position.

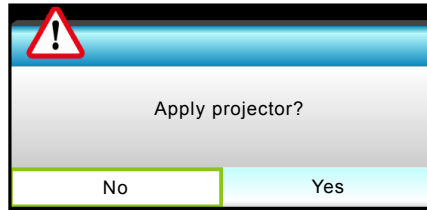

Note: *Rear-Desktop and Rear-Ceiling are to be used with a translucent screen.*

Menu Location

Choose the menu location on the display screen.

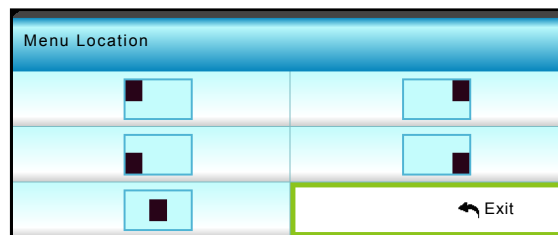

Screen Type

Choose the screen type from 16:10 or 16:9 (WXGA/WUXGA).

Note: *"Screen Type" is for WXGA only.*

Projector ID

ID definition can be set up by menu (range 0-99), and allow user control an individual projector by RS232.



Exit

Choose "Exit" to exit the menu.

USING THE PROJECTOR

Setup audio settings menu

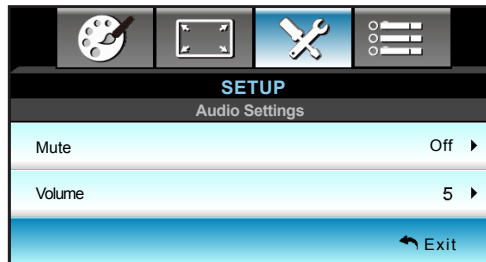

Mute

Use this option to temporarily turn off the sound.



- Choose the "On" to turn mute on.
- Choose the "Off" to turn mute off.

Note: "Mute" function affects both internal and external speaker volume.

Volume

Adjust the volume level.



- Press the ◀ to decrease the volume.
- Press the ▶ to increase the volume.

Exit

Choose "Exit" to exit the menu.

USING THE PROJECTOR

Setup security menu



Security

Enable this function to prompt for a password before using the projector.

- On: Choose "On" to use security verification when the turning on the projector.
- Off: Choose "Off" to be able to switch on the projector without password verification.



Security Timer

Can be select the time (Month/Day/Hour) function to set the number of hours the projector can be used. Once this time has elapsed you will be requested to enter your password again.

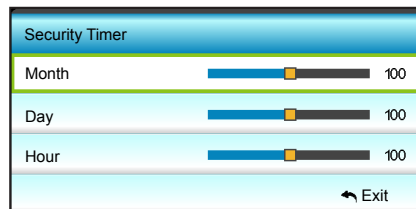

Change Password

Change the password.

- ***First time:***
 1. Press the "Enter" key to set the password.
 2. The password has to be 4 digits.
 3. Use number button on the remote control or on-screen numeric keypad to enter your new password and then press the "Enter" key to confirm your password.
- ***Change Password:***
 1. Press the "Enter" key to input old password.
 2. Use the number button or on-screen numeric keypad to enter the current password and then press the "Enter" key to confirm.
 3. Enter new password (4 digits in length) using the number buttons on the remote control, then press the "Enter" key to confirm.
 4. Enter the new password again and press the "Enter" key to confirm.

If the incorrect password is entered 3 times, the projector will automatically shut down.

If you have forgotten your password, please contact your local office for support.

USING THE PROJECTOR

Note: The password default value is "1234" (first time).

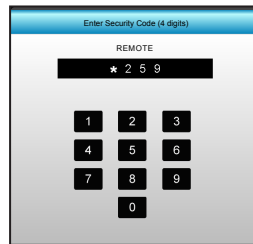

Exit

Choose "Exit" to exit the menu.

USING THE PROJECTOR

Setup advanced menu

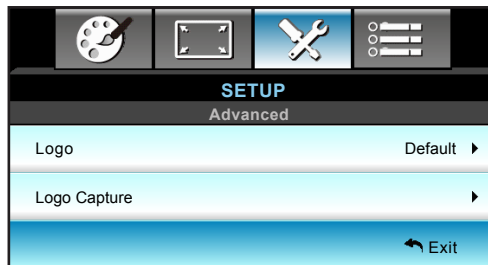

Logo

Use this function to set the desired startup screen. If changes are made, they will take effect the next time the projector is powered on.

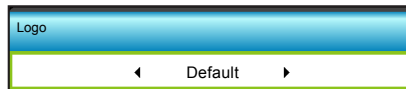

- Default: The default startup screen.
- Neutral: Logo is not displayed on startup screen.

Logo Capture

Press ► to capture an image of the picture currently displayed on the screen.

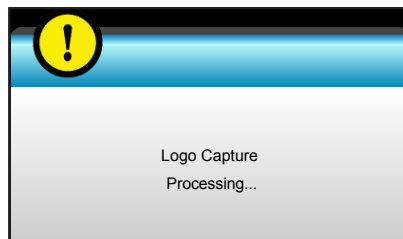

Note: For a successful logo capture, ensure that the on-screen image does not exceed the projector native resolution. (1080p: 1920x1080).

Exit

Choose "Exit" to exit the menu.

USING THE PROJECTOR

Options menu

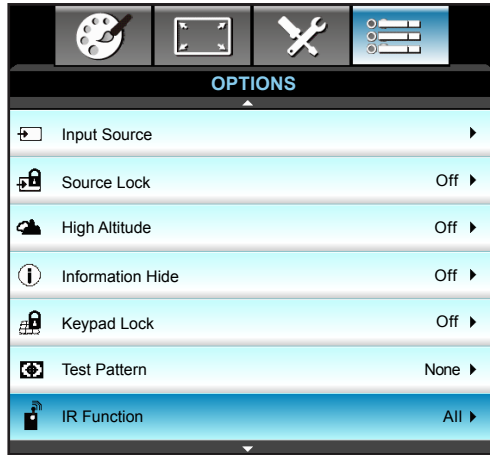

Input Source

Use this option to enable/disable input sources. Press the ► to enter the sub menu and select which sources you require. Press the "Enter" key to finalize the selection. The projector will only search for inputs that are enabled.

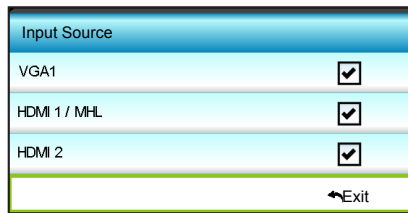

Source Lock

Use this function to let the projector to search for current input only or any input signals.

- On: The projector will only search current input connection.
- Off: The projector will search for other signals if the current input signal is lost.



High Altitude

When "On" is selected, the fans will spin faster. This feature is useful in high altitude areas where the air is thin.



Information Hide

Enable this function to hide the information message.

- On: Choose "On" to hide the info message.
- Off: Choose "Off" to show the "searching" message.



USING THE PROJECTOR

Keypad Lock

When the keypad lock function is "On", the Keypad will be locked. However, the projector can be operated by the remote control. By selecting "Off", you will be able to reuse the Keypad.

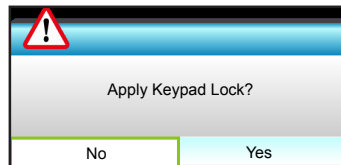

Test Pattern

Display a test pattern. The available options are Grid, White Pattern and None.



IR Function

Set the IR function setting.

- On: Choose "On", the projector can be operated by the remote control from front or top IR receiver.
- Front: Choose "Front", the projector can be operated by the remote control from front IR receiver.
- Top: Choose "Top", the projector can be operated by the remote control from top IR receiver.
- Off: Choose "Off", the projector can't be operated by the remote control from front or top IR receiver. By selecting "Off", you will be able to use the Keypad keys.

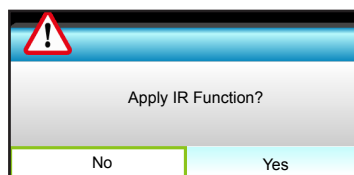

Note:

- "Front" and "Top" cannot be selected in standby mode.
- IR mode can be switched to "NVIDIA 3D Vision" once implemented and verified by NVIDIA.

USING THE PROJECTOR

Options menu

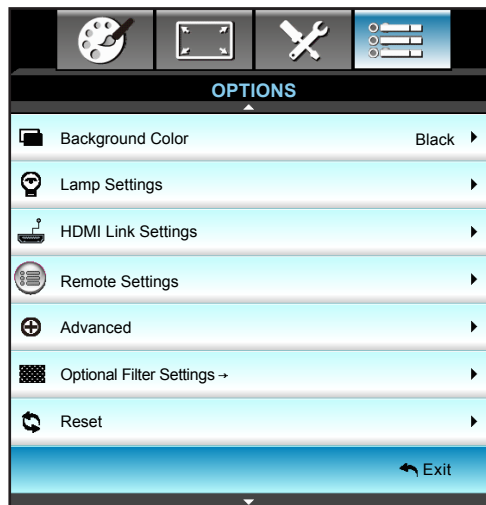

Background Color

Use this feature to display a "Black", "Red", "Blue", "Green", or "White" screen when no signal is available.

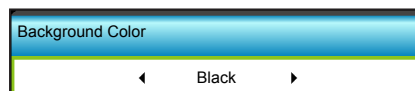

USING THE PROJECTOR

Options lamp settings menu

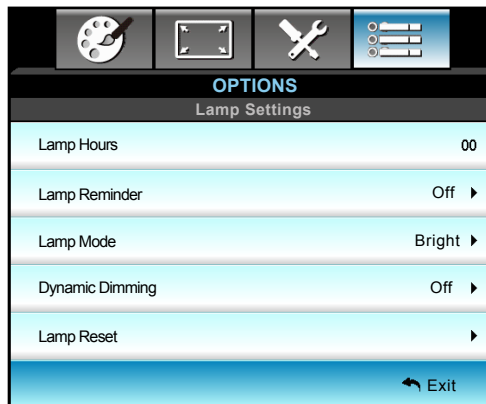

Lamp Hours

Display the projection time.

Lamp Reminder

Choose this function to show or to hide the warning message when the changing lamp message is displayed. The message will appear 30 hours before suggested replacement of lamp.



Lamp Mode

Set the lamp mode setting.

- Bright: Choose "Bright" to increase the brightness.
- Eco.: Choose "Eco." to dim the projector lamp which will lower power consumption and extend the lamp life.
- Dynamic: Choose "Dynamic" to dim the lamp power which will be based on brightness level of the content and adjust lamp power consumption between 100% and 30% dynamically. The lamp life will be extended.
- Eco+: When Eco+ mode is activated, the brightness level of the content is automatically detected to significantly reduced lamp power consumption (up to 70%) during periods of inactivity.



Dynamic Dimming

Set to configure the dynamic dimming setting.

- On: When select Dynamic "On", the options in lamp modes will be "Dynamic".
- Off: When select Dynamic "Off", the options in lamp modes will be "Bright" and "ECO".



USING THE PROJECTOR

Lamp Reset

Resets the lamp hour counter after replacing the lamp.

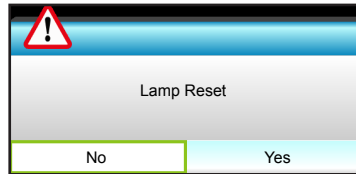

Exit

Choose "Exit" to exit the menu.

Note:

- *When ambient temperature is over 40°C during operation, the projector will switch to Eco automatically.*
- *The "Lamp Mode" can be independently set for 2D and 3D.*
- *The Dynamic mode-lamp power can be dynamically adjusted from 100% to 30%.*

USING THE PROJECTOR

Options HDMI link settings menu

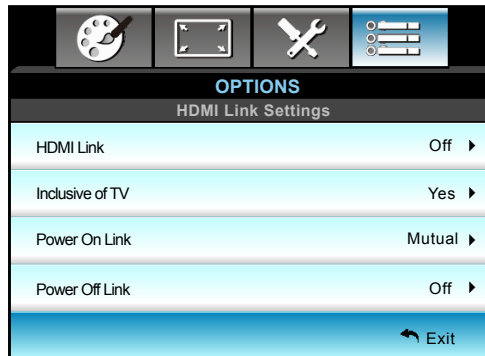

Using HDMI Link

- When you connect HDMI CEC-compatible devices to the projector with HDMI cables, you can control them on same Power On or Power Off status using the HDMI Link control feature on the projector's OSD.
- This lets one device or multiple devices in a group Power On or Power Off via HDMI Link Feature.
- In a typical configuration, your DVD player may be connected to the projector through an amplifier or home theater system.

HDMI Link

Enable/Disable the HDMI Link function. The Inclusive TV, Power on Link, and Power off Link options will only available if the setting.



Inclusive of TV

If the setting is set to "Yes", both TV and projector will be automatically turned off at the same time. To prevent both devices to be turned off at the same time, set the setting to "No".



Power On Link

CEC power on command:

- Mutual: Both projector and CEC device will be turned on simultaneously.
- PJ -> Device: The CEC device will be turned on only after the projector is switched on.
- Device -> PJ: The projector will be switched on only after the CEC device is turned on.



- Press the ► into the next menu and then use the ◀ or ▶ to select "Mutual", "PJ -> Device", "Device -> PJ" item.

USING THE PROJECTOR

Power Off Link

If the setting is set to “On”, both HDMI Link and projector will be automatically turned off at the same time. Set to “Off”, both HDMI Link and projector will be not automatically turned off at the same time.



Exit

Choose “Exit” to exit the menu.

USING THE PROJECTOR

Options remote settings menu

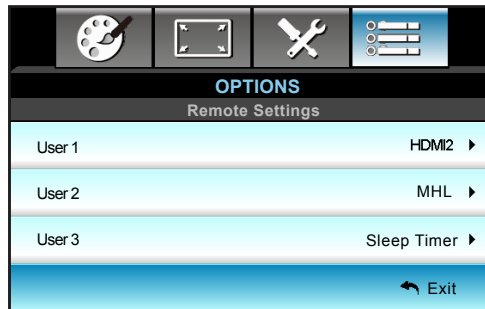

USER 1

Assign the default function for USER 1. The default value is "HDMI2".



- Press the ► into the next menu and then use the ◀ or the ▶ to select "HDMI2", "Brightness", "Contrast", "Sleep Timer", "Test Pattern", "MHL" item.

USER 2

Assign the default function for USER 2. The default value is "MHL".

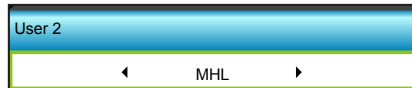

- Press the ► into the next menu and then use the ◀ or the ▶ to select "HDMI2", "Brightness", "Contrast", "Sleep Timer", "Test Pattern", "MHL" item.

USER 3

Assign the default function for USER 3. The default value is "Sleep Timer".

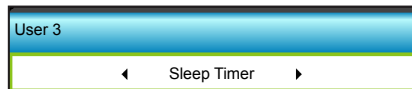

- Press the ► into the next menu and then use the ◀ or the ▶ to select "HDMI2", "Brightness", "Contrast", "Sleep Timer", "Test Pattern", "MHL" item.

USING THE PROJECTOR

Options optional filter settings menu

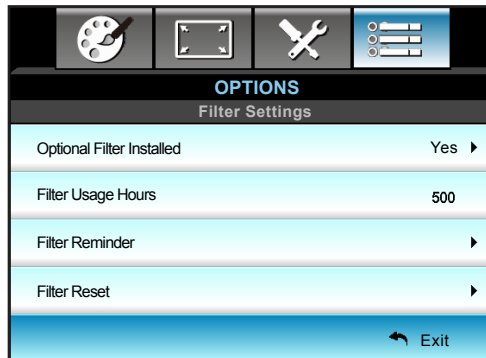

Optional Filter Installed

Set the warning message setting.

- Yes: Display warning message after 500 hours of use.

Note: “Filter Usage Hours / Filter Reminder / Filter Reset” will only appear when “Optional Filter Installed” is “Yes”.

- No: Turn off warning message.

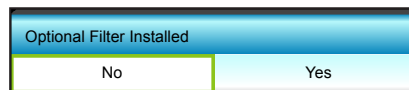

Filter Usage Hours

Display the filter time.

Filter Reminder

Choose this function to show or hide the warning message when the changing filter message is displayed. (Factory default setting: 500 hours).

Filter Reset

Reset the dust filter counter after replacing or cleaning the dust filter.

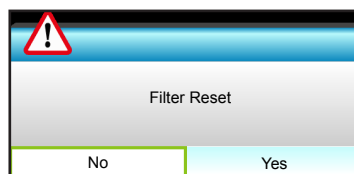

Exit

Choose “Exit” to exit the menu.

USING THE PROJECTOR

Options advanced menu

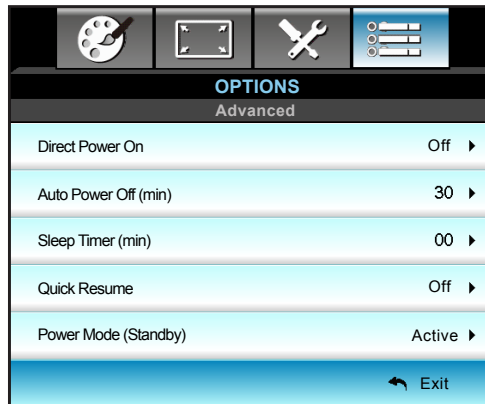

Direct Power On

Choose "On" to activate Direct Power mode. The projector will automatically power on when AC power is supplied, without pressing the "⏻" key on the projector keypad or on the remote control.



Auto Power Off (min)

Set the countdown timer interval. The countdown timer will start, when there is no signal being sent to the projector. The projector will automatically power off when the countdown has finished (in minutes).

- Press the ◀ to decrease the timer interval.
- Press the ▶ to increase the timer interval.

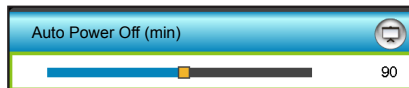

Note:

- *The value of sleep timer will be reset to zero after the projector is powered off.*
- *The projector will automatically power off when the countdown has finished. The default setting is 20 minutes.*

Sleep Timer (min)

Sets the countdown timer interval. The countdown timer will start, with or without a signal being sent to the projector. The projector will automatically power off when the countdown has finished (in minutes).

- Press the ◀ to decrease the timer interval.
- Press the ▶ to increase the timer interval.

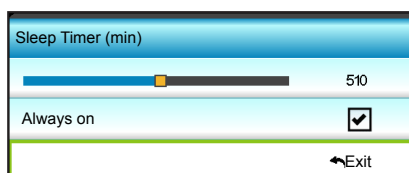

USING THE PROJECTOR

Quick Resume

Set the quick resume setting.

- On: If the projector is accidentally turned off, this feature allows the projector to be instantly powered on again, if selected within a period of 100 seconds.
- Off: The fan will start cooling the system after 10 seconds when user turns off the projector.



Power Mode (Standby)

Set the power mode setting.

- Active: Choose "Active" to return to normal standby.
- Eco.: Choose "Eco." to save power dissipation further $< 0.5W$.

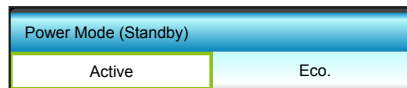

Exit

Choose "Exit" to exit the menu.

USING THE PROJECTOR

3D Setup

1. Turn on your projector.
2. Connect your 3D source. For example, 3D Blu ray, Games console, PC, Set top box, etc.
3. Ensure you have inserted 3D content or selected the 3D channel.
4. Turn on your 3D glasses. Please refer to the 3D glasses user manual on how to operate the 3D glasses.
5. Your projector will automatically display 3D from a 3D Blu-ray. For 3D via a set top box or PC, you will be required to adjust the settings in the 3D menu.

For 3D via Blu ray

3D will automatically be displayed.

- Menu > "Display" > "3D" > "3D Mode" > "DLP Link"

For 3D via a PC or Set top box

3D will not be displayed automatically. Depending on the 3D content the image will either be displayed side by side or top and bottom. Please refer to the following table.

SBS	SBS	Top and bottom
		Top and bottom

- For side by side images, select "SBS" in the menu. Menu > "Display" > "3D" > "3D Format" > "SBS".
 - For top and bottom images, select "top and bottom" in the menu. Menu > "Display" > "3D" > "3D Format" > "Top and bottom".
- If the 3D image does not look correct, you may also be required to adjust the 3D sync invert. Turn this on if the image looks odd. Menu > "Display" > "3D" > "3D Sync Invert" > "On".

Note: *If input video is normal 2D, please press "3D format" and switch to "Auto". If "SBS" mode is active, 2D video content will not be displayed correctly. Please change back to "Auto" when 3D via a PC only works with certain resolutions. Please check the compatibility on page 63.*

MAINTENANCE

Replacing the lamp

The projector automatically detects the lamp life. When the lamp life is nearing the end of use, a warning message will appear on the screen.

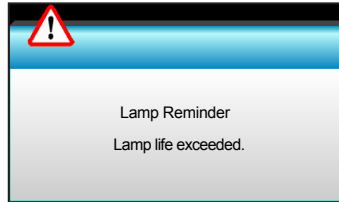

When you see this message, please contact your local reseller or service center to change the lamp as soon as possible. Make sure the projector has been cooled down for at least 30 minutes before changing the lamp.



Warning: If ceiling mounted, please use caution when opening the lamp access panel. It is recommended to wear safety glasses if changing the bulb when ceiling mounted. Caution must be used to prevent any loose parts from falling out of projector.



Warning: Lamp compartment is hot! Allow it to cool down before changing lamp!



Warning: To reduce the risk of personal injury, do not drop the lamp module or touch the lamp bulb. The bulb may shatter and cause injury if it is dropped.

MAINTENANCE

Replacing the lamp (continued)

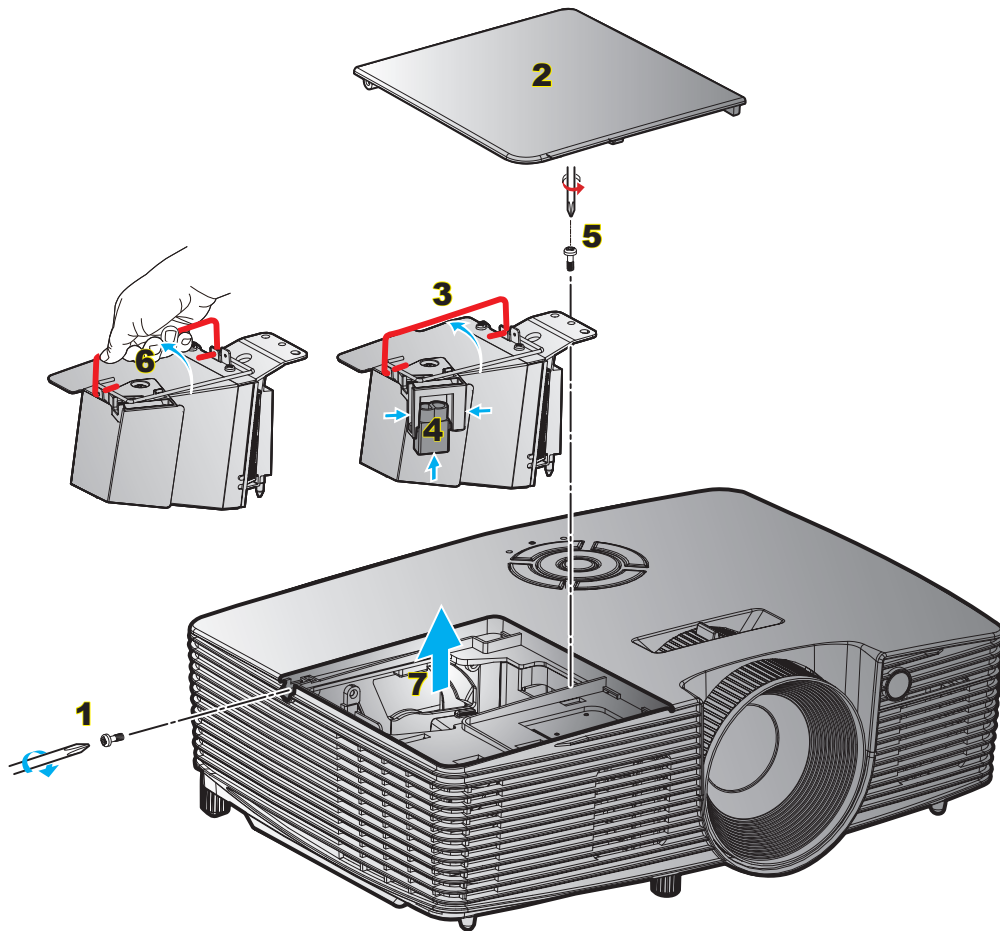

Procedure:

1. Switch off the power to the projector by pressing the "⏻" button on the remote control or the projector keypad.
2. Allow the projector to cool down for at least 30 minutes.
3. Disconnect the power cord.
4. Unscrew the screw on the cover. **1**
5. Open the cover. **2**
6. Lift up the lamp handle. **3**
7. Press both sides, then lift up and remove the lamp cord. **4**
8. Unscrew the screw on the lamp module. **5**
9. Lift up the lamp handle **6** and remove the lamp module carefully. **7**
10. To replace the lamp module, reverse the previous steps.
11. Turn on the projector and reset the lamp timer.
12. Lamp Reset: (i) Press "Menu" → (ii) Select "OPTIONS" → (iii) Select "Lamp Settings" → (iv) Select "Lamp Reset" → (v) Select "Yes".

MAINTENANCE

Note:

- *The screw on the lamp cover and the lamp cannot be removed.*
- *The projector cannot be turned on if the lamp cover has not been placed back on the projector.*
- *Do not touch the glass area of the lamp. Hand oil can cause the lamp shatter. Use a dry cloth to clean the lamp module if it was accidentally touched.*

MAINTENANCE

Installing and cleaning the dust filter

Installing the dust filter

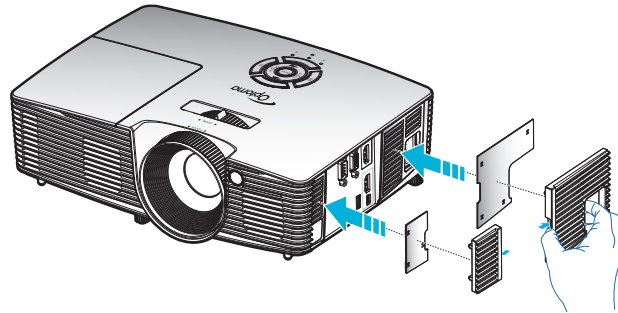

Note: Dust filters are only required/supplied in the selected regions with excessive dust.

Cleaning the dust filter

We recommend you to clean the dust filter every three months. Clean it more often if the projector is used in a dusty environment.

Procedure:

1. Switch off the power to the projector by pressing the "⏻" button on the remote control or the projector keypad.
2. Disconnect the power cord.
3. Remove the dust filter carefully.
4. Clean or replace the dust filter.
5. To install the dust filter, reverse the previous steps.

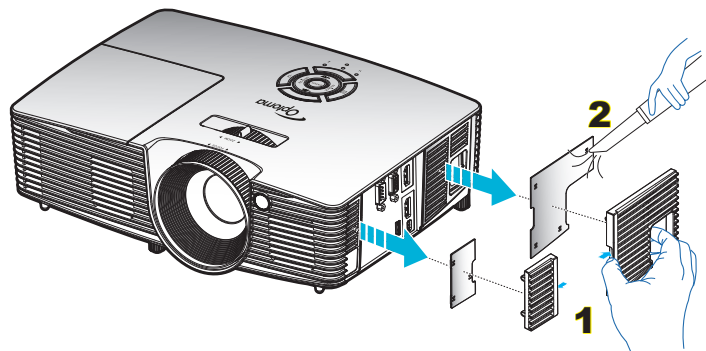

ADDITIONAL INFORMATION

Compatible resolutions

Digital compatibility

B0/Established Timing	B0/Standard Timing	B0/Detail Timing	B1/Video Mode	B1/Detail Timing
720x400 @ 70Hz	1280x720 @ 60Hz	Native timing:	640x480p @ 60Hz	720x480p @ 60Hz
640x480 @ 60Hz	1280x800 @ 60Hz	1080P: 1920x1080 @ 60Hz	720x480p @ 60Hz	1280x720p @ 60Hz
640x480 @ 67Hz	1280x1024 @ 60Hz		1280x720p @ 60Hz	1366x768 @ 60Hz
640x480 @ 72Hz	1400x1050 @ 60Hz		1920x1080i @ 60Hz	1920x1080i @ 50Hz
640x480 @ 75Hz	1600x1200 @ 60Hz		720(1440)x480i @ 60Hz	1920x1080p @ 60Hz
800x600 @ 56Hz			1920x1080p @ 60Hz	
800x600 @ 60Hz	1440x900 @ 60Hz		720x576p @ 50Hz	
800x600 @ 72Hz	1280x720 @ 120Hz		1280x720p @ 50Hz	
800x600 @ 75Hz	1024x768 @ 120Hz		1920x1080i @ 50Hz	
832x624 @ 75Hz			720(1440)x576i @ 50Hz	
1024x768 @ 60Hz			1920x1080p @ 50Hz	
1024x768 @ 70Hz			1920x1080p @ 24Hz	
1024x768 @ 75Hz			1920x1080p @ 30Hz	
1280x1024 @ 75Hz				
1152x870 @ 75Hz				

Analog compatibility

B0/Established Timing	B0/Standard Timing	B0/Detail Timing	B1/Video Mode	B1/Detail Timing
720x400 @ 70Hz	1080P:	1080P: 1920x1080 @60Hz		1366x768 @ 60Hz
640x480 @ 60Hz	1280x720 @ 60Hz			
640x480 @ 67Hz	1280x800 @ 60Hz			
640x480 @ 72Hz	1280x1024 @ 60Hz			
640x480 @ 75Hz	1400x1050 @ 60Hz			
800x600 @ 56Hz	1600x1200 @ 60Hz			
800x600 @ 60Hz	1440x900 @ 60Hz			
800x600 @ 72Hz	1280x720 @ 120Hz			
800x600 @ 75Hz	1024x768 @ 120Hz			
832x624 @ 75Hz				
1024x768 @ 60Hz				
1024x768 @ 70Hz				
1024x768 @ 75Hz				
1280x1024 @ 75Hz				
1152x870 @ 75Hz				

True 3D video compatibility

Input resolution	HDMI 1.4a 3D Input	Input timing		
		1280x720P @ 50Hz	Top - and - Bottom	
		1280x720P @ 60Hz	Top - and - Bottom	
		1280x720P @ 50Hz	Frame packing	
		1280x720P @ 60Hz	Frame packing	
		1920x1080i @ 50 Hz	Side- by-Side (Half)	
		1920x1080i @ 60 Hz	Side- by-Side (Half)	
		1920x1080P @ 24 Hz	Top - and- Bottom	
	1920x1080P @ 24 Hz	Frame packing		
	HDMI 1.3	1920x1080i @ 50Hz	Side-by-Side(Half)	SBS mode is on
		1920x1080i @ 60Hz		
		1280x720P @ 50Hz		
		1280x720P @ 60Hz	Top-and-Bottom	TAB mode is on
		1920x1080i @ 50Hz		
		1920x1080i @ 60Hz		
		1280x720P @ 50Hz		
		1280x720P @ 60Hz	HQFS	3D format is Frame sequential
480i				

Note:

- *If 3D input is 1080p@24hz, the DMD should replay with integral multiple with 3D mode.*
- *Support NVIDIA 3DTV Play if there is no patent fee from Optoma 1080i@25hz and 720p@50hz will run in 100 hz; other 3D timing will run in 120hz.*
- *1080p@24hz will run in 144Hz.*

ADDITIONAL INFORMATION

Image size and projection distance

(1080P)

Diagonal Length Size of (16:9) Screen	Screen Size W x H				Projection Distance (D)				Offset	
	(m)		(inch)		(m)		(inch)			
	Width	Height	Width	Height	Wide	Tele	Wide	Tele	(m)	(inch)
36	0.80	0.45	31.38	17.65	1.2	1.3	3.94	4.27	0.07	2.76
40	0.89	0.5	34.86	19.6	1.3	1.4	4.27	4.59	0.08	3.15
50	1.11	0.62	43.58	24.5	1.6	1.8	5.25	5.91	0.10	3.94
60	1.33	0.75	52.29	29.4	2.0	2.2	6.56	7.22	0.12	4.72
70	1.55	0.87	61.01	34.3	2.3	2.5	7.55	8.20	0.14	5.51
80	1.77	1	69.73	39.2	2.6	2.9	8.53	9.51	0.16	6.30
90	1.99	1.12	78.44	44.1	2.9	3.2	9.51	10.50	0.18	7.09
100	2.21	1.25	87.16	49	3.3	3.6	10.83	11.81	0.19	7.48
120	2.66	1.49	104.59	58.8	3.9	4.3	12.80	14.11	0.24	9.45
150	3.32	1.87	130.74	73.5	4.9	5.4	16.08	17.72	0.30	11.81
180	3.98	2.24	156.88	88.2	5.9	6.5	19.36	21.33	0.36	14.17
200	4.43	2.49	174.32	98.1	6.6	7.2	21.65	23.62	0.40	15.75
250	5.53	3.11	217.89	122.6	8.2	9.0	26.90	29.53	0.50	19.69
300	6.64	3.74	261.47	147.1	9.8	10.8	32.15	35.43	0.59	23.23

Note: Zoom ratio is 1.1x.

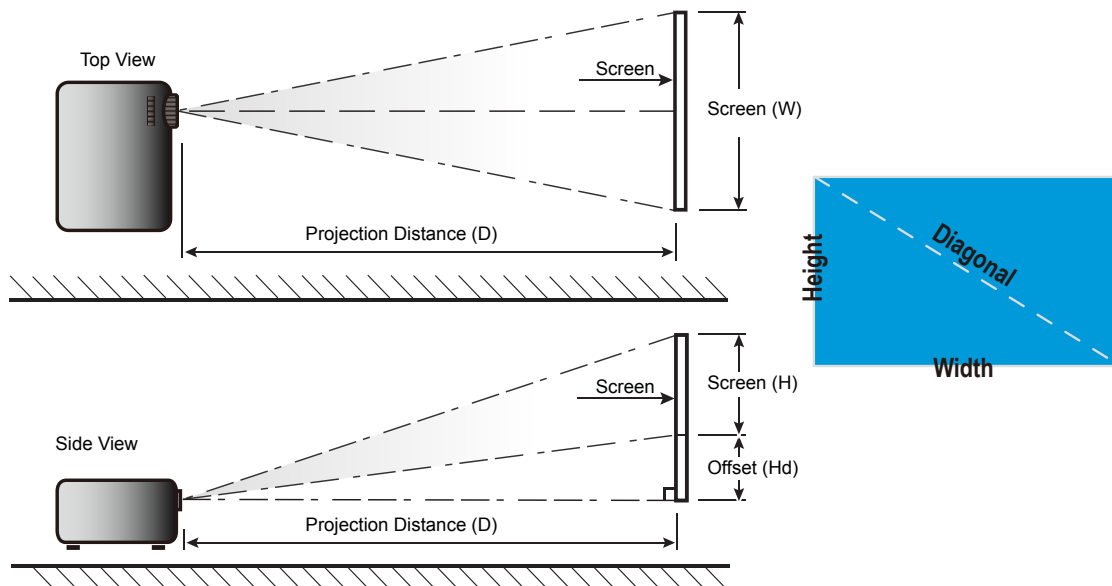

ADDITIONAL INFORMATION

Projector dimensions and ceiling mount installation

1. To prevent damage to your projector, please use the Optoma ceiling mount.
2. If you wish to use a third party ceiling mount kit, please ensure the screws used to attach a mount to the projector meet the following specifications:
 - Screw type: M4*3
 - Minimum screw length: 10mm

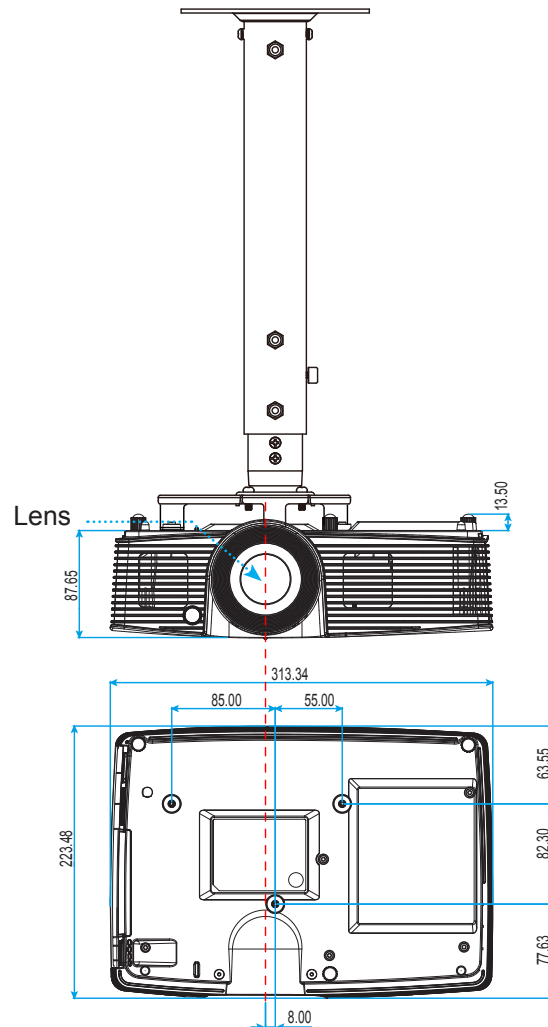

Unit: mm

Note: Please note that damage resulting from incorrect installation will void the warranty.



Warning:

- If you buy a ceiling mount from another company, please be sure to use the correct screw size. Screw size will vary depending on the thickness of the mounting plate.
- Be sure to keep at least 10 cm gap between the ceiling and the bottom of the projector.
- Avoid installing the projector near a heat source.

ADDITIONAL INFORMATION

RS232 protocol function list

Baud Rate : 9600

Data Bits: 8

Parity: None

Stop Bits: 1

Flow Control : None

UART16550 FIFO: Disable

Projector Return (Pass): P

Projector Return (Fail): F

XX=01-99, projector's ID, XX=00 is for all projectors

Note: There is a <CR> after all ASCII commands 0D is the HEX code for <CR> in ASCII code.

SEND to projector				
232 ASCII Code	HEX Code	Function	Description	
~XX00 1	7E 30 30 30 30 20 31 0D	Power ON		
~XX00 0	7E 30 30 30 30 20 30 0D	Power OFF	(0/2 for backward compatible)	
~XX00 1	7E 30 30 30 30 20 31 20a0D	Power ON with Password	~nnnn = ~0000 (a=7E 30 30 30 30)	
	~nnnn		~9999 (a=7E 39 39 39 39)	
~XX01 1	7E 30 30 30 31 20 31 0D	Resync		
~XX02 1	7E 30 30 30 32 20 31 0D	AV Mute	On	
~XX02 0	7E 30 30 30 32 20 30 0D		Off (0/2 for backward compatible)	
~XX03 1	7E 30 30 30 33 20 31 0D	Mute	On	
~XX03 2	7E 30 30 30 33 20 30 0D		Off (0/2 for backward compatible)	
~XX04 1	7E 30 30 30 34 20 31 0D	Freeze		
~XX04 0	7E 30 30 30 34 20 30 0D	Unfreeze	(0/2 for backward compatible)	
~XX05 1	7E 30 30 30 35 20 31 0D	Zoom Plus		
~XX06 1	7E 30 30 30 36 20 31 0D	Zoom Minus		
~XX12 1	7E 30 30 31 32 20 31 0D	Direct Source Commands	HDMI1	
~XX12 15	7E 30 30 31 32 20 31 35 0D		HDMI2	
~XX12 5	7E 30 30 31 32 20 35 0D		VGA1	
~XX12 8	7E 30 30 31 32 20 38 0D		VGA1 Component	
~XX20 2	7E 30 30 32 30 20 32 0D		Bright	
~XX20 3	7E 30 30 32 30 20 33 0D		Movie	
~XX20 4	7E 30 30 32 30 20 34 0D		sRGB	
~XX20 5	7E 30 30 32 30 20 35 0D		User	
~XX20 7	7E 30 30 32 30 20 37 0D		Blackboard	
~XX20 9	7E 30 30 32 30 20 39 0D		3D	
~XX21 n	7E 30 30 32 31 20 a 0D	Brightness	n = -50 (a=2D 35 30) ~ 50 (a=35 30)	
~XX22 n	7E 30 30 32 32 20 a 0D	Contrast	n = -50 (a=2D 35 30) ~ 50 (a=35 30)	
~XX23 n	7E 30 30 32 33 20 a 0D	Sharpness	n = 1 (a=31) ~ 15 (a=31 35)	
~XX24 n	7E 30 30 32 34 20 a 0D	Color Settings/White	Red	n = -50 (a=2D 35 30) ~ 50 (a=35 30)
~XX25 n	7E 30 30 32 35 20 a 0D		Green	n = -50 (a=2D 35 30) ~ 50 (a=35 30)
~XX26 n	7E 30 30 32 36 20 a 0D		Blue	n = -50 (a=2D 35 30) ~ 50 (a=35 30) n = -50 (a=2D 35 30) ~ 50 (a=35 30)
~XX33 1	7E 30 30 33 33 20 31 0D		Reset	
~XX34 n	7E 30 30 33 34 20 a 0D	BrilliantColor™	n = 1 (a=30) ~ 10 (a=31 30)	
~XX35 1	7E 30 30 33 35 20 31 0D	Gamma	Film	
~XX35 2	7E 30 30 33 35 20 32 0D		Video	
~XX35 3	7E 30 30 33 35 20 33 0D		Graphics	
~XX35 4	7E 30 30 33 35 20 34 0D		Standard	
~XX36 1	7E 30 30 33 36 20 31 0D	Color Temp.	Warm	
~XX36 2	7E 30 30 33 36 20 32 0D	Color Temp.	Medium	
~XX36 3	7E 30 30 33 36 20 33 0D	Color Temp.	Cold(D83)	
~XX37 1	7E 30 30 33 37 20 31 0D	Color Space	Auto	
~XX37 2	7E 30 30 33 37 20 32 0D		RGB\ RGB(0-255)	
~XX37 3	7E 30 30 33 37 20 33 0D		YUV	
~XX37 4	7E 30 30 33 37 20 34 0D		RGB(16 - 235)	
~XX73 n	7E 30 30 37 33 20 a 0D	Signal	Frequency	n = -5 (a=2D 35) ~ 5 (a=35) By signal

ADDITIONAL INFORMATION

232 ASCII Code	HEX Code	Function	Description
~XX91 n	7E 30 30 39 31 20 a 0D		Automatic n = 0 disable; n = 1 enable
~XX74 n	7E 30 30 37 34 20 a 0D		Phase n = 0 (a=30) ~ 31 (a=33 31) By signal
~XX75 n	7E 30 30 37 35 20 a 0D		H. Position n = -5 (a=2D 35) ~ 5 (a=35) By timing
~XX76 n	7E 30 30 37 36 20 a 0D		V. Position n = -5 (a=2D 35) ~ 5 (a=35) By timing
~XX45 n	7E 30 30 34 34 20 a 0D	Color (Saturation)	n = -50 (a=2D 35 30) ~ 50 (a=35 30)
~XX44 n	7E 30 30 34 35 20 a 0D	Tint	n = -50 (a=2D 35 30) ~ 50 (a=35 30)
~XX60 1	7E 30 30 36 30 20 31 0D	Format	4:3
~XX60 2	7E 30 30 36 30 20 32 0D		16:9
~XX60 5	7E 30 30 36 30 20 35 0D		LBX
~XX60 6	7E 30 30 36 30 20 36 0D		Native
~XX60 7	7E 30 30 36 30 20 37 0D		Auto
~XX61 n	7E 30 30 36 31 20 a 0D	Edge mask	n = 0 (a=30) ~ 10 (a=31 30)
~XX62 n	7E 30 30 36 32 20 a 0D	Zoom	n = -5 (a=2D 35) ~ 25 (a=32 35)
~XX63 n	7E 30 30 36 33 20 a 0D	H Image Shift	n = -100 (a=2D 31 30 30) ~ 100 (a=31 30 30)
~XX64 n	7E 30 30 36 34 20 a 0D	V Image Shift	n = -100 (a=2D 31 30 30) ~ 100 (a=31 30 30)
~XX66 n	7E 30 30 36 36 20 a 0D	V Keystone	n = -40 (a=2D 34 30) ~ 40 (a=34 30)
~XX230 0	7E 30 30 32 33 30 20 30 0D	3D Mode	OFF
~XX230 1	7E 30 30 32 33 30 20 31 0D	3D Mode	DLP-Link
~XX230 3	7E 30 30 32 33 30 20 33 0D	3D Mode	IR
~XX400 0	7E 30 30 34 30 30 20 30 0D	3D->2D	3D
~XX400 1	7E 30 30 34 30 30 20 31 0D		L
~XX400 2	7E 30 30 34 30 30 20 32 0D		R
~XX405 0	7E 30 30 34 30 35 20 30 0D	3D Format	Auto
~XX405 1	7E 30 30 34 30 35 20 31 0D		SBS
~XX405 2	7E 30 30 34 30 35 20 32 0D		Top and Bottom
~XX405 3	7E 30 30 34 30 35 20 33 0D		Frame sequential
~XX231 0	7E 30 30 32 33 31 20 30 0D	3D Sync Invert	On
~XX231 1	7E 30 30 32 33 31 20 31 0D	3D Sync Invert	Off
~XX70 1	7E 30 30 37 30 20 31 0D	Language	English
~XX70 2	7E 30 30 37 30 20 32 0D		German
~XX70 3	7E 30 30 37 30 20 33 0D		French
~XX70 4	7E 30 30 37 30 20 34 0D		Italian
~XX70 5	7E 30 30 37 30 20 35 0D		Spanish
~XX70 6	7E 30 30 37 30 20 36 0D		Portuguese
~XX70 7	7E 30 30 37 30 20 37 0D		Polish
~XX70 8	7E 30 30 37 30 20 38 0D		Dutch
~XX70 9	7E 30 30 37 30 20 39 0D		Swedish
~XX70 10	7E 30 30 37 30 20 31 30 0D		Norwegian/Danish
~XX70 11	7E 30 30 37 30 20 31 31 0D		Finnish
~XX70 12	7E 30 30 37 30 20 31 32 0D		Greek
~XX70 13	7E 30 30 37 30 20 31 33 0D		Traditional Chinese
~XX70 14	7E 30 30 37 30 20 31 34 0D		Simplified Chinese
~XX70 15	7E 30 30 37 30 20 31 35 0D		Japanese
~XX70 16	7E 30 30 37 30 20 31 36 0D		Korean
~XX70 17	7E 30 30 37 30 20 31 37 0D		Russian
~XX70 18	7E 30 30 37 30 20 31 38 0D		Hungarian
~XX70 19	7E 30 30 37 30 20 31 39 0D		Czechoslovak
~XX70 20	7E 30 30 37 30 20 32 30 0D		Arabic
~XX70 21	7E 30 30 37 30 20 32 31 0D		Thai
~XX70 22	7E 30 30 37 30 20 32 32 0D		Turkish
~XX70 23	7E 30 30 37 30 20 32 33 0D		Farsi
~XX70 25	7E 30 30 37 30 20 32 33 0D		Vietnamese
~XX70 26	7E 30 30 37 30 20 32 33 0D		Indonesian
~XX70 27	7E 30 30 37 30 20 32 33 0D		Romanian
~XX71 1	7E 30 30 37 31 20 31 0D	Projection	Front-Desktop
~XX71 2	7E 30 30 37 31 20 32 0D		Rear-Desktop
~XX71 3	7E 30 30 37 31 20 33 0D		Front-Ceiling
~XX71 4	7E 30 30 37 31 20 34 0D		Rear-Ceiling

ADDITIONAL INFORMATION

232 ASCII Code	HEX Code	Function	Description
~XX72 1	7E 30 30 37 32 20 31 0D	Menu Location	Top Left
~XX72 2	7E 30 30 37 32 20 32 0D		Top Right
~XX72 3	7E 30 30 37 32 20 33 0D		Centre
~XX72 4	7E 30 30 37 32 20 34 0D		Bottom Left
~XX72 5	7E 30 30 37 32 20 35 0D		Bottom Right
~XX77 n	7E 30 30 37 37 20 aabbcc 0D	Security	Security Timer Month/Day/Hour n = mm/dd/hh mm= 00 (aa=30 30) ~ 12 (aa=31 32) dd = 00 (bb=30 30) ~ 30 (bb=33 30) hh= 00 (cc=30 30) ~ 24 (cc=32 34)
~XX78 1	7E 30 30 37 38 20 31 0D	Security Settings	Enable
~XX78 0	7E 30 30 37 38 20 32 20		Disable(0/2 for backward compatible)
~nnnn	a 0D		~nnnn = ~0000 (a=7E 30 30 30 30) ~9999 (a=7E 39 39 39 39)
~XX79 n	7E 30 30 37 39 20 a 0D	Projector ID	n = 00 (a=30 30) ~ 99 (a=39 39)
~XX80 1	7E 30 30 38 30 20 31 0D	Mute	On
~XX80 0	7E 30 30 38 30 20 30 0D		Off (0/2 for backward compatible)
~XX310 0	7E 30 30 33 31 30 20 30 0D	Internal Speaker	Off
~XX310 1	7E 30 30 33 31 30 20 31 0D		On
~XX81 n	7E 30 30 38 31 20 a 0D	Volume(Audio)	n = 0 (a=30) ~ 10 (a=31 30)
~XX82 1	7E 30 30 38 32 20 31 0D	Logo	Default
~XX82 3	7E 30 30 38 32 20 33 0D		Neutral
~XX100 1	7E 30 30 31 30 30 20 31 0D	Source Lock	On
~XX100 0	7E 30 30 31 30 30 20 30 0D		Off (0/2 for backward compatible)
~XX101 1	7E 30 30 31 30 31 20 31 0D	High Altitude	On
~XX101 0	7E 30 30 31 30 31 20 30 0D		Off (0/2 for backward compatible)
~XX102 1	7E 30 30 31 30 32 20 31 0D	Information Hide	On
~XX102 0	7E 30 30 31 30 32 20 30 0D		Off (0/2 for backward compatible)
~XX103 1	7E 30 30 31 30 33 20 31 0D	Keypad Lock	On
~XX103 0	7E 30 30 31 30 33 20 30 0D		Off (0/2 for backward compatible)
~XX195 0	7E 30 30 31 39 35 20 30 0D	Test Pattern	None
~XX195 1	7E 30 30 31 39 35 20 31 0D		Grid
~XX195 2	7E 30 30 31 39 35 20 32 0D		White Pattern
~XX111 1	7E 30 30 31 31 20 31 0D	IR Function	n=1 On
~XX111 0	7E 30 30 31 31 20 30 0D	IR Function	n=0 Off_All
~XX111 2	7E 30 30 31 31 20 32 0D	IR Function	n=2 Off_Front
~XX111 3	7E 30 30 31 31 20 33 0D	IR Function	n=3 Off_Top
~XX104 1	7E 30 30 31 30 34 20 31 0D	Background Color	Blue
~XX104 2	7E 30 30 31 30 34 20 32 0D		Black
~XX104 3	7E 30 30 31 30 34 20 33 0D		Red
~XX104 4	7E 30 30 31 30 34 20 34 0D		Green
~XX104 5	7E 30 30 31 30 34 20 35 0D		White
~XX105 1	7E 30 30 31 30 35 20 31 0D	Advanced	Direct Power On On
~XX105 0	7E 30 30 31 30 35 20 30 0D		Off (0/2 for backward compatible)
~XX106 n	7E 30 30 31 30 36 20 a 0D	Auto Power Off	n = 0 (a=30) ~ 180 (a=31 38 30) (min)
~XX107 n	7E 30 30 31 30 37 20 a 0D	Sleep Timer (min)	n = 0 (a=30) ~ 990 (a=39 39 39)
~XX115 1	7E 30 30 31 31 35 20 31 0D	Quick Resume	On
~XX115 0	7E 30 30 31 31 35 20 30 0D		Off (0/2 for backward compatible)
~XX114 1	7E 30 30 31 31 34 20 31 0D	Power Mode(Standby)	Eco.(≤0.5W)
~XX114 0	7E 30 30 31 31 34 20 30 0D		Active (0/2 for backward compatible)
~XX109 1	7E 30 30 31 30 39 20 31 0D	Lamp Reminder	On
~XX109 0	7E 30 30 31 30 39 20 30 0D		Off (0/2 for backward compatible)
~XX110 1	7E 30 30 31 31 30 20 31 0D	Brightness Mode	Bright
~XX110 2	7E 30 30 31 31 30 20 32 0D		Eco
~XX110 3	7E 30 30 31 31 30 20 33 0D		Eco+
~XX110 4	7E 30 30 31 31 30 20 34 0D		Dynamic

ADDITIONAL INFORMATION

232 ASCII Code	HEX Code	Function	Description	
~XX111 1	7E 30 30 31 31 31 20 31 0D	Lamp Reset	Yes	
~XX111 0	7E 30 30 31 31 31 20 30 0D		No (0/2 for backward compatible)	
~XX322 0	7E 30 30 33 32 32 20 30 0D	Filter Reminder	Off	
~XX322 1	7E 30 30 33 32 32 20 31 0D		300 hrs	
~XX322 2	7E 30 30 33 32 32 20 32 0D		500 hrs	
~XX322 3	7E 30 30 33 32 32 20 33 0D		800 hrs	
~XX322 4	7E 30 30 33 32 32 20 34 0D		1000 hrs	
~XX323 1	7E 30 30 33 32 33 20 31 0D	Filter Reset	Yes	
~XX323 0	7E 30 30 33 32 33 20 30 0D		No	
~XX112 1	7E 30 30 31 31 32 20 31 0D	Reset	Yes	
~XX99 1	7E 30 30 39 39 20 31 0D	RS232 Alert Reset	Reset System Alert	
~XX210 n	7E 30 30 32 30 30 20 n 0D	Display message on the OSD	n: 1-30 characters	
SEND to emulate Remote				
~XX140 10	7E 30 30 31 34 30 20 31 30 0D	Up		
~XX140 11	7E 30 30 31 34 30 20 31 31 0D	Left		
~XX140 12	7E 30 30 31 34 30 20 31 32 0D	Enter (for projection MENU)		
~XX140 13	7E 30 30 31 34 30 20 31 33 0D	Right		
~XX140 14	7E 30 30 31 34 30 20 31 34 0D	Down		
~XX140 15	7E 30 30 31 34 30 20 31 35 0D	Keystone +		
~XX140 16	7E 30 30 31 34 30 20 31 36 0D	Keystone -		
~XX140 17	7E 30 30 31 34 30 20 31 37 0D	Volume -		
~XX140 18	7E 30 30 31 34 30 20 31 38 0D	Volume +		
~XX140 19	7E 30 30 31 34 30 20 31 39 0D	Brightness		
~XX140 20	7E 30 30 31 34 30 20 32 30 0D	Menu		
~XX140 21	7E 30 30 31 34 30 20 32 31 0D	Zoom		
~XX140 28	7E 30 30 31 34 30 20 32 38 0D	Contrast		
~XX140 47	7E 30 30 31 34 30 20 34 37 0D	Source		
SEND from projector automatically				
232 ASCII Code	HEX Code	Function	Projector Return	Description
when Standby/Cooling/Out of Range/Lamp fail/Fan Lock/Over Temperature/Lamp Hours Running Out/Cover Open			INFO n	n : 0/1/2/3/4/5/6/7/8 = Standby/Warming/Cooling/Out of Range/Lamp fail/Fan Lock/Over Temperature/Lamp Hours Running Out/Cover Open
READ from projector				
232 ASCII Code	HEX Code	Function	Projector Return	Description
~XX121 1	7E 30 30 31 32 31 20 31 0D	Input Source Commands	Ok n	n = 0 None n = 2 VGA-1 n = 7 HDMI1 n = 8 HDMI2 n = 11 Component
~XX122 1	7E 30 30 31 32 32 20 31 0D	Software Version	OK dddd	dddd: FW version

ADDITIONAL INFORMATION

232 ASCII Code	HEX Code	Function	Projector Return	Description
~XX123 1	7E 30 30 31 32 33 20 31 0D	Display Mode	OKn	n = 0 None n = 1 Presentation n = 2 Bright/ n = 3 Movie n = 4 sRGB n = 5 User n = 7 Blackboard n = 9 3D
~XX124 1	7E 30 30 31 32 34 20 31 0D	Power State	OKn	n : 0/1 = Off/On
~XX125 1	7E 30 30 31 32 35 20 31 0D	Brightness	OKn	
~XX126 1	7E 30 30 31 32 36 20 31 0D	Contrast	OKn	
~XX127 1	7E 30 30 31 32 37 20 31 0D	Aspect Ratio	OKn	n = 1 4:3 n = 2 16:9 n = 5 LBX n = 6 Native n = 7 Auto
*16:9 or 16:10 depend on Screen Type setting				
~XX128 1	7E 30 30 31 32 38 20 31 0D	Color Temperature	OKn	n = 0 Warm n = 1 Medium n = 2 Cold
~XX129 1	7E 30 30 31 32 39 20 31 0D	Projection Mode	OKn	n = 0 Front-Desktop n = 1 Rear-Desktop n = 2 Front-Ceiling n = 3 Rear-Ceiling
~XX150 1	7E 30 30 31 35 30 20 31 1D	Information	OKabbbbccdddde	a : 0/1 = Off/On bbbb: LampHour cc: source = None/VGA1/VGA2/Video/S-Video/HDMI dddd: FW version e = Display mode e=0 None e=1 Presentation e=2 Bright e=3 Movie e=4 sRGB e=5 User e=6 Blackboard e=7 3D
~XX151 1	7E 30 30 31 35 31 20 31 0D	Model name	OKn	n:4= 1080p
~XX108 1	7E 30 30 31 30 38 20 31 0D	Lamp Hours	OKbbbb	bbbb: LampHour
~XX108 2	7E 30 30 31 30 38 20 32 0D	Cumulative Lamp Hours	OKbbbbbb	bbbbbb: (5 digits) Total Lamp Hours
~XX321 1	7E 30 30 33 32 31 20 31 0D	Filter Usage Hours	OKbbbb	bbbb: Filter Usage Hours

ADDITIONAL INFORMATION

IR remote codes



Key	Key code	Printing-key definition	Description
Power	81	Power on/off	Press to turn on / off the projector.
Switch	3E	Switch	Press to switch the USB mouse on / off.
Display blank / audio mute	8A		Press to hide / unhide the screen picture and turn off / on audio.
Freeze	8B	Freeze	Press to freeze the projector image.
Mute	92		Press to momentarily turn off / on the audio.
Mouse left click	CB	L	Use as mouse left click.
Mouse right click	CC	R	Use as mouse right click.
Four directional select keys	C6	Up arrow	Use ▲ ▼ ◀ ▶ to select items or make adjustments to your selection.
	C8	Left arrow	
	C9	Right arrow	
	C7	Down arrow	
Enter	C5	Enter	Confirm your item selection.
	CA	Enter	
Page -	C2	Page-	Press to page down.
Laser	N/A	Laser	Use as laser pointer.

ADDITIONAL INFORMATION

Key		Key code	Printing-key definition	Description
Page +		C1	Page+	Press to page up.
Keystone		85	Keystone+	Press to adjust image distortion caused by tilting the projector.
		84	Keystone-	
Volume		8C	Volume +	Press to adjust to increase / decrease the volume.
		8F	Volume -	
Aspect ratio / 1		98	/ 1	<ul style="list-style-type: none"> Press to change aspect ratio of a displayed image. Use as numeric keypad number "1".
Menu / 2		88	Menu/2	<ul style="list-style-type: none"> Press to display or exit the on-screen display menus for projector. Use as numeric keypad number "2".
3D / 3		93	3D/3	<ul style="list-style-type: none"> Press to manually select a 3D mode that matches your 3D content. Use as numeric keypad number "3".
HDMI / 4		86	HDMI/4	<ul style="list-style-type: none"> Press to choose HDMI source. Use as numeric keypad number "4".
VGA / 5		D0	VGA/5	<ul style="list-style-type: none"> Press to choose VGA source. Use as numeric keypad number "5".
Video / 6		D1	Video/6	<ul style="list-style-type: none"> Press to choose composite video source. Use as numeric keypad number "6".
User1 / 7; User2 / 8; User3 / 9		D2	User 1/7	<ul style="list-style-type: none"> User defined keys. Please see page 53 to setup. Use as numeric keypad numbers "7", "8", and "9" accordingly.
		D3	User 2/8	
		D4	User 3/9	
Source		C3	Source	Press to select an input signal.
Brightness mode / 0		96	/ 0	<ul style="list-style-type: none"> Press to automatically adjust the picture brightness to give an optimum contrast performance. Use as numeric keypad number "0".
Re-sync		C4	Re-Sync	Press to automatically synchronize the projector to the input source.

ADDITIONAL INFORMATION

Using the Help button

The Help function ensures easy setup and operation. Press the “?” button on the keypad to open the Help menu.

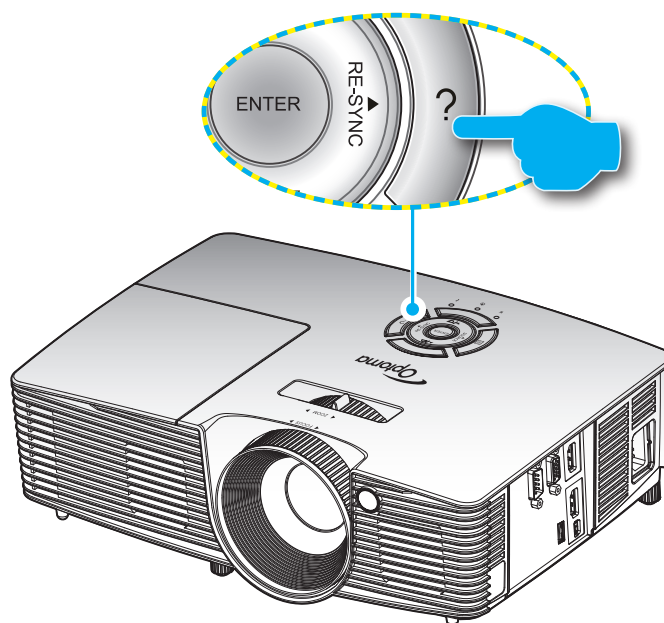

- **Help** button functions only when no input source is detected.

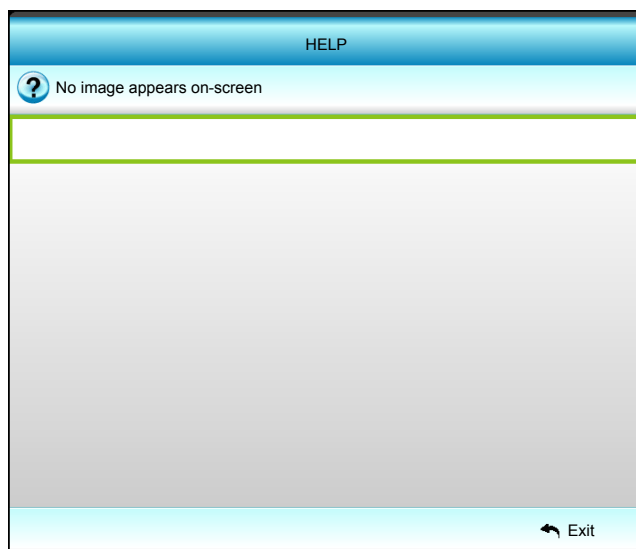

ADDITIONAL INFORMATION

HELP

? No image appears on-screen

- ▶ Ensure all the cables and power connections are correctly and securely connected as described in the Installation section of User's Manual.
- ▶ Ensure all the pins of connectors are not bent or broken.
- ▶ Ensure that the [AV MUTE] feature is not turned on.

[Next]

↩ Exit

HELP

? No image appears on-screen

- ▶ If you are using a Notebook :
 1. First, follow the steps above to adjust resolution of the computer.
 2. Press the toggle output settings. Example : [Fn]+[F4]

Acer → [Fn]+[F5]	IBM/Lenovo → [Fn]+[F7]
Asus → [Fn]+[F8]	HP/Compaq → [Fn]+[F4]
Dell → [Fn]+[F8]	NEC → [Fn]+[F3]
Gateway → [Fn]+[F4]	Toshiba → [Fn]+[F5]

Mac Apple:
System Preference -> Display -> Arrangement -> Mirror display

[Prev]

↩ Exit

HELP

- ?** Image has slanted sides
- ?** Image is too small or too large
- ?** Image is unstable or flickering
- ?** There is no audio heard or the volume is too low

↩ Exit

ADDITIONAL INFORMATION

HELP

 Image has slanted sides

- ▶ If possible, reposition the projector so that is centered on the screen and below the bottom of the screen.
- ▶ Press [KEYSTONE + / -] button until the sides are vertical on the remote control.

[KEYSTONE + / -]

 Exit

HELP

 Image is too small or too large



- ▶ Adjust the Zoom Ring on the top of projector.
- ▶ Move the projector closer to or further from the screen.
- ▶ Press [MENU] button on the remote control or projector panel, go to DISPLAY | Format and try the different settings.

[DISPLAY | Format]

 Exit

HELP

 There is no audio heard or the volume is too low

-  Is the volume setting at the minimum?
 - ▶ Turn up the volume setting.
-  Is the cable connected properly to the projector?
 - ▶ Check the physical connection and ensure the cable is connected properly from the source to projector.

[Volume]

 Exit

ADDITIONAL INFORMATION

HELP

? Image is unstable or flickering

- ▶ Use [Phase / Frequency] to correct it.
- ▶ Change the monitor color setting on your computer.

[Phase]

[Frequency]







↩ Exit

ADDITIONAL INFORMATION



Troubleshooting

If you experience a problem with your projector, please refer to the following information. If a problem persists, please contact your local reseller or service center.



Image problems

-  *No image appears on-screen*
- Ensure all the cables and power connections are correctly and securely connected as described in the "Installation" section.
 - Ensure the pins of connectors are not crooked or broken.
 - Check if the projection lamp has been securely installed. Please refer to the "Replacing the Lamp" section.
 - Ensure that the "AV Mute" feature is not turned on.
-  *Image is out of focus*
- Adjust the Focus Ring on the projector lens.
 - Make sure the projection screen is between the required distance from the projector. (Please refer to page 64).
-  *The image is stretched when displaying 16:9 DVD title*
- When you play anamorphic DVD or 16:9 DVD, the projector will show the best image in 16: 9 format on projector side.
 - If you play the LBX format DVD title, please change the format as LBX in projector OSD.
 - If you play 4:3 format DVD title, please change the format as 4:3 in projector OSD.
 - Please setup the display format as 16:9 (wide) aspect ratio type on your DVD player.
-  *Image is too small or too large*
- Adjust the zoom lever on the top of the projector.
 - Move the projector closer to or further from the screen.
 - Press "Menu" on the projector panel, go to "Display-->Format". Try the different settings.
-  *Image has slanted sides:*
- If possible, reposition the projector so that it is centered on the screen and below the bottom of the screen.
 - Use "Display-->V Keystone" from the OSD to make an adjustment.
-  *Image is reversed*
- Select "Setup-->Projection" from the OSD and adjust the projection direction.
-  *Blurry double image*
- Press "3D Format" button and switch to "Off" to avoid normal 2D image is blurry double image.

ADDITIONAL INFORMATION

-  *Two images, side-by-side format*
- Press "3D Format" button and switch to "SBS" for input signal is HDMI 1.3 2D 1080i side-by-side.
-  *Image does not display in 3D*
- Check if the battery of 3D glasses is drained.
 - Check if the 3D glasses is turned on.
 - When the input signal is HDMI 1.3 2D (1080i side-by-side half), press "3D Format" button and switch to "SBS".

Other problems

-  *The projector stops responding to all controls*
- If possible, turn off the projector, then unplug the power cord and wait at least 20 seconds before reconnecting power.
-  *Lamp burns out or makes a popping sound*
- When the lamp reaches its end of life, it will burn out and may make a loud popping sound. If this happens, the projector will not turn on until the lamp module has been replaced. To replace the lamp, follow the procedures in the "Replacing the Lamp" section on pages 58-60.

Remote control problems

-  *If the remote control does not work*
- Check the operating angle of the remote control is pointed within $\pm 15^\circ$ both horizontally and vertically to the IR receivers on the projector.
 - Make sure there are not any obstructions between the remote control and the projector. Move to within 5 m (16 ft) of the projector.
 - Make sure batteries are inserted correctly.
 - Replace batteries if they are exhausted.

ADDITIONAL INFORMATION

















Warning indicators

When the warning indicators (see below) light up or flash, the projector will automatically shutdown:

- "LAMP" LED indicator is lit red and if "On/Standby" indicator flashes amber.
- "TEMP" LED indicator is lit red and if "On/Standby" indicator flashes amber. This indicates the projector has overheated. Under normal conditions, the project can be switched back on.
- "TEMP" LED indicator flashes red and if "On/Standby" indicator flashes amber.

Unplug the power cord from the projector, wait for 30 seconds and try again. If the warning indicator light up or flash, please contact your nearest service center for assistance.

LED lightning messages

Message	 Power LED	 Power LED	 Temp-LED	 Lamp-LED
	(Red)	(Green or Blue)	(Red)	(Red)
Standby state (Input power cord)	Steady light			
Power on (Warming)		Flashing (0.5 sec off / 0.5 sec on)		
Power on and Lamp lighting		Steady light		
Power off (Cooling)		Flashing (0.5 sec off / 0.5 sec light). Back to red steady light when cooling fan turns off.		
Quick Resume (100 secs)		Flashing (0.25 sec off / 0.25 sec light)		
Error (Over temp.)	Flashing			
Error (Fan failure)	Flashing		Flashing	
Error (Lamp failure)	Flashing			

ADDITIONAL INFORMATION

- Power off:

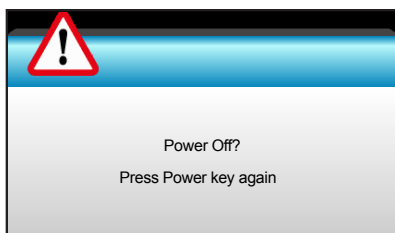

- Lamp warning:

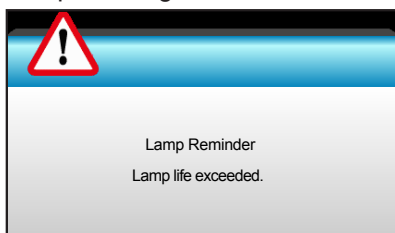

- Temperature warning:

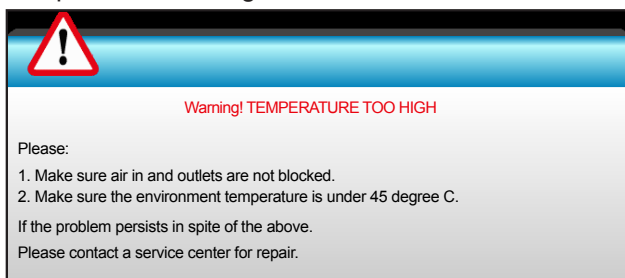

- Fan failed:

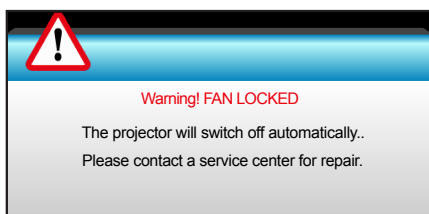

- Out of display range:



- Calibration failed:



ADDITIONAL INFORMATION

- Power down warning:

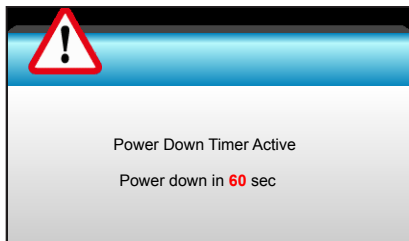

- Security timer alarm:

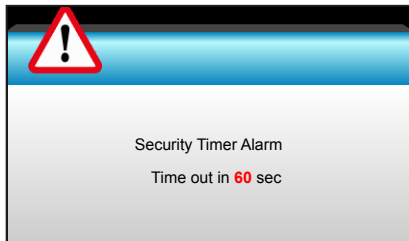

ADDITIONAL INFORMATION

Specifications

Optical	Description
Maximum resolution	- Video timing maximum up to :1080p - Graphic up to WUXGA@60Hz
Lens	- Manual zoom and manual focus
Lamp	- ECO Mode < = 0.5 W @110/220VAC - Active Mode (>0.5W) @110/220VAC
Image size (diagonal)	- 41.8"~305" (with ME travel) - 41.8"~305" (focus range with optimized at 60" image size)
Projection distance	- 1.5m~10m (with ME travel) - 1.5m~10m (focus range with optimized at 60" image size)

Electrical	Description
Inputs	VGA-IN/YPbPr connector, HDMI 1/MHL connector, HDMI 2 connector
Outputs	USB Power Out (1.5A) connector
Service port	RS-232 connector, Mouse/Service connector
Color reproduction	1073.4 Million color
Scan rate	- Horizontal scan rate: 15.375~91.146 KHz - Vertical scan rate: 24~ 85 Hz (120Hz for 3D featured projector)
Built-in speaker	Yes, 10W
Power requirement	100 - 240V AC 50/60Hz
Input current	2.5-1.0 A

Mechanical	Description
Installation orientation	Desktop/Front, Desktop/Rear, Ceiling/Front, Ceiling/Rear
Dimensions	314.3 mm (W) x 223.6 mm (D) x 88.2 mm (H)
Weight	2.5 kg
Environmental conditions	Operating: 5 ~ 40°C in Bright mode and ECO mode 10% to 85% humidity (non-condensing)

Note: All specifications are subject to change without notice.



ADDITIONAL INFORMATION

Optoma global offices

For service or support, please contact your local office.



USA

3178 Laurelview Ct.
Fremont, CA 94538, USA
www.optomausa.com

 888-289-6786
 510-897-8601
 services@optoma.com



Canada

3178 Laurelview Ct.
Fremont, CA 94538, USA
www.optomausa.com

 888-289-6786
 510-897-8601
 services@optoma.com

Latin America

3178 Laurelview Ct.
Fremont, CA 94538, USA
www.optomausa.com

 888-289-6786
 510-897-8601
 services@optoma.com



Europe

42 Caxton Way, The Watford Business Park
Watford, Hertfordshire,
WD18 8QZ, UK
www.optoma.eu
Service Tel : +44 (0)1923 691865

 +44 (0) 1923 691 800
 +44 (0) 1923 691 888
 service@tsc-europe.com



Benelux BV

Randstad 22-123
1316 BW Almere
The Netherlands
www.optoma.nl

 +31 (0) 36 820 0252
 +31 (0) 36 548 9052



France

Bâtiment E
81-83 avenue Edouard Vaillant
92100 Boulogne Billancourt, France

 +33 1 41 46 12 20
 +33 1 41 46 94 35
 savoptoma@optoma.fr



Spain

C/ José Hierro,36 Of. 1C
28522 Rivas VaciaMadrid,
Spain

 +34 91 499 06 06
 +34 91 670 08 32



Deutschland

Wiesenstrasse 21 W
D40549 Düsseldorf,
Germany

 +49 (0) 211 506 6670
 +49 (0) 211 506 66799
 info@optoma.de

Scandinavia



Lerpeveien 25
3040 Drammen
Norway

 +47 32 98 89 90
 +47 32 98 89 99
 info@optoma.no

PO.BOX 9515
3038 Drammen
Norway

Korea

WOOMI TECH.CO.,LTD.
4F, Minu Bldg.33-14, Kangnam-Ku,
Seoul,135-815, KOREA
korea.optoma.com

 +82+2+34430004
 +82+2+34430005



Japan

東京都足立区綾瀬3-25-18
株式会社オーエス
コンタクトセンター:0120-380-495

 info@os-worldwide.com
www.os-worldwide.com



Taiwan

12F., No.213, Sec. 3, Beixin Rd.,
Xindian Dist., New Taipei City 231,
Taiwan, R.O.C.
www.optoma.com.tw

 +886-2-8911-8600
 +886-2-8911-6550
 services@optoma.com.tw
asia.optoma.com



Hong Kong

Unit A, 27/F Dragon Centre,
79 Wing Hong Street,
Cheung Sha Wan,
Kowloon, Hong Kong

 +852-2396-8968
 +852-2370-1222
www.optoma.com.hk

China

5F, No. 1205, Kaixuan Rd.,
Changning District
Shanghai, 200052, China

 +86-21-62947376
 +86-21-62947375
www.optoma.com.cn

